



Mersa Medical
INSTRUMENTS
Manufacturer & Exporter of Quality Instruments



Manufacturer & Exporter of

Ophthalmic Instruments

www.mersamedical.com



Calipers

4



Speculums

5 - 7



Retractors

7 - 9



Depressors

9



Hooks/Manipulators

10 - 22



Fixation Rings/Markers

23 - 25

Scissors

25 - 36



Forceps

36 - 44



Needle Holders

45 - 47



Dilator/Lacrimal Probes

47 - 48

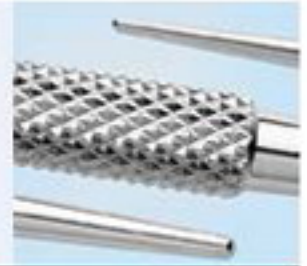

Cannulas

49 - 56



Miscellaneous

57





BRAUNSTEIN Calipers

MA001R

3.5/4.0 mm, 2 $\frac{3}{4}$ "

MA002R

3.0/3.5 mm, 2 $\frac{3}{4}$ "

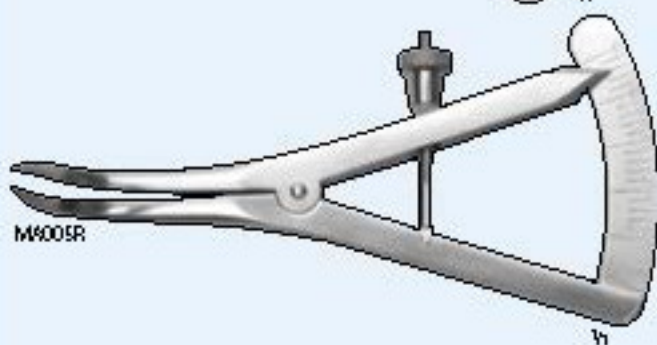
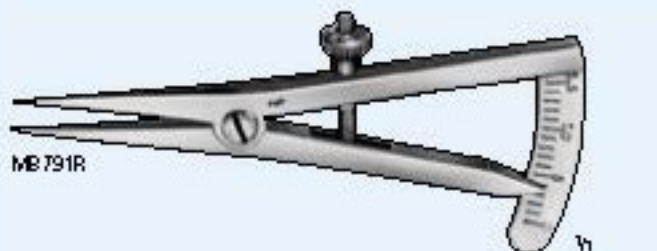

CASTROVIEJO Eye Calipers

MB791R

Straight, Range 0-15 mm, 3 $\frac{1}{8}$ "

MA005R

Curved, Range 0-20 mm, 3 $\frac{1}{8}$ "

BARRAQUER Eye Speculums

MA751R

10 mm Blades, 1½"

OA200R

14 mm Blades, 1¾"

MA752R

Heavy Wire, 14 mm, 1¾"

MA754R

15 mm Solid Blades, 1¾"



MA751R

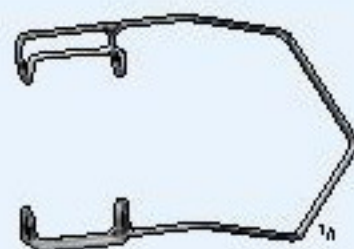

MA752R

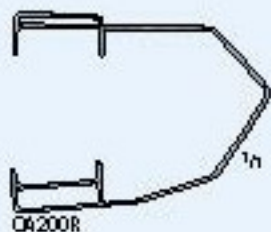

OA200R

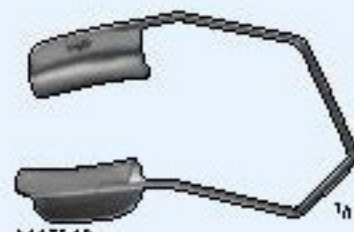

MA754R

KRATZ-BARRAQUER Eye Speculums

MA756R

Pediatric, 10 mm, 1¾"

MA755R

14 mm Blades, 1½"

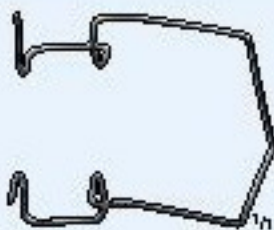

MA756R

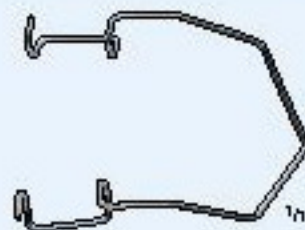

MA755R

ALPHONSO Infant Speculum

MA757R

5 mm & 9 mm wide x 7 mm deep Blades, 1¾"

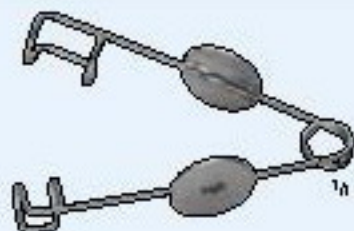

MA757R

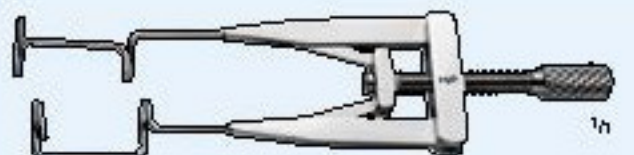

MA750R

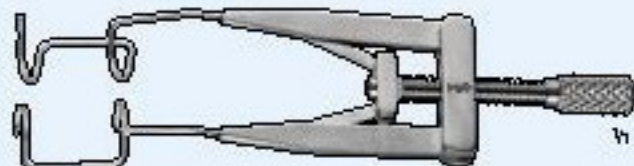

MA758R

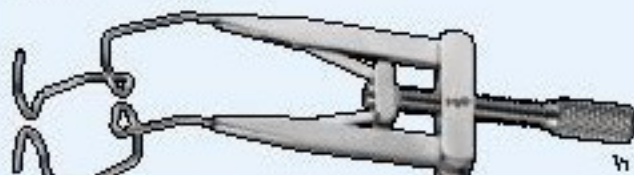

MA759R

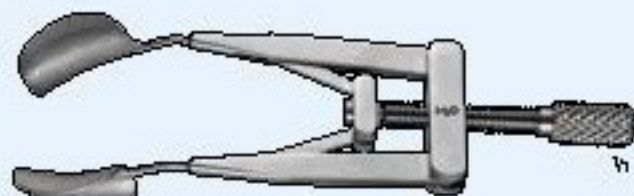

MA760R

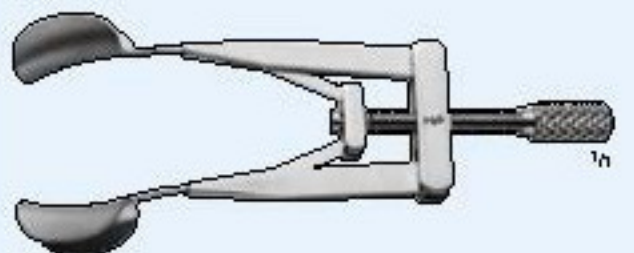

MA764R

LIEBERMAN Adjustable Speculums

MA750R

Straight, 16 mm Square Wire Blades, 3 1/8"

MA758R

Angled, 14 mm Square Wire Blades, 3 1/4" Length

MA759R

Angled, 14 mm V-Shaped Wire Blades, 3 1/4" Length

MA760R

Angled, 14 mm Solid Blades, 3 1/4" Length

MA764R

Reversible, Angled, 14 mm Solid Blades, 3 1/8"



MA762R



MA763R

JAFFE Wire Lid Retractors

MA762R

15 mm Blades, Pair, 1 1/2"

MA763R

13 mm Blades, Pair, 1 1/2"

SAUER Eye Speculums

OA218R

11 mm Blades, 1 $\frac{1}{8}$ "



OA218R

LANCASTER Eye Speculum

OA225R

15 mm Wide, x 7 mm Deep, 3 $\frac{1}{8}$ "

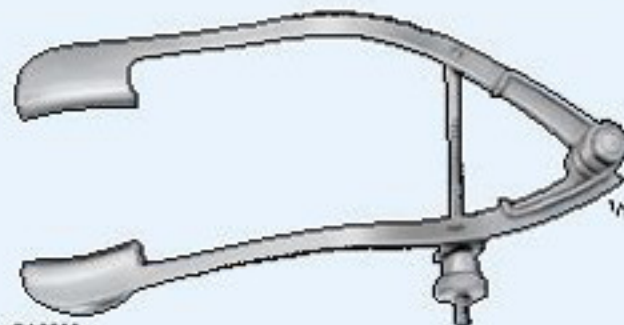

OA225R

DESMARRES Lid Retractors

OA310R

9 x 9 mm, 5 $\frac{1}{2}$ "

OA311R

9 x 12 mm, 5 $\frac{1}{2}$ "

OA312R

11 x 14 mm, 5 $\frac{1}{2}$ "

OA313R

12 x 16 mm, 5 $\frac{1}{2}$ "

OA314R

13 x 18 mm, 5 $\frac{1}{2}$ "



OA310R-OA314R



OA310R



OA311R



OA312R



OA313R



OA314R

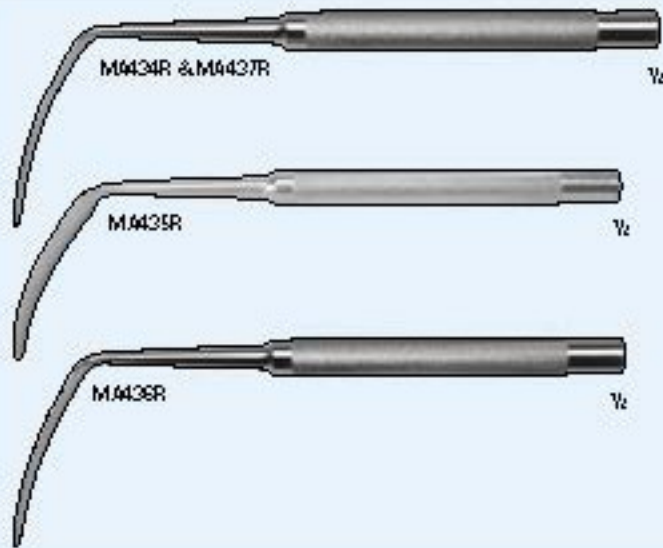

SEWALL Orbital Retractors

M44 34 R

7 x 52 mm Blade, 6 $\frac{3}{4}$ "

M44 35 R

9 x 44 mm Blade, 6 $\frac{3}{8}$ "

M44 36 R

11 x 50 mm Blade, 6 $\frac{3}{8}$ "

M44 37 R

13 x 67 mm Blade, 6 $\frac{3}{4}$ "



SCHEPENS Orbital Retractor

MA749R

Smooth, 14 x 61 Blade, 6 $\frac{1}{8}$ "



JAEGER Lid Plate

MA765

Clear Plastic, 20 mm / 23 mm Wide, 3 $\frac{3}{4}$ "



BERKE-JAEGER Lid Plate

MA766R

20 mm / 30 mm Wide, 4 $\frac{1}{4}$ "



WELLS Enucleation Spoon

MA731R

21 mm Diameter, 5 $\frac{3}{4}$ "

WHITMAN SHEPHERD Capsule Polisher

MA777R

Double Ended, Left Angled, Right Angled, 5 1/2"



KOCH Stop and Chop Manipulator

MA778R

Angled Shaft with 1.5 mm Tip, 4 3/4"

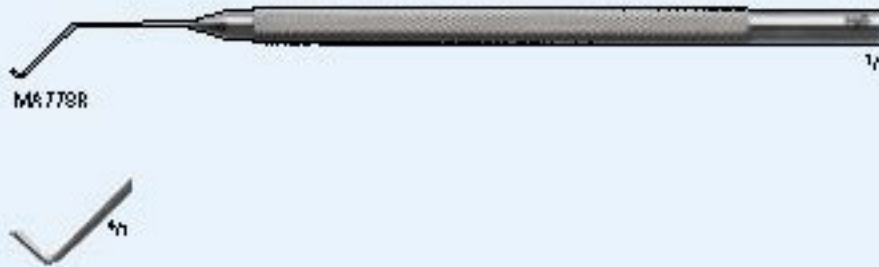

CAMELLIN-style LASEK Alcohol Well

MA779R

8.5 mm Diameter, 4 1/2"



SLOANE LASEK Spatulas

MA780R

Micro Hoe, Semicircular Tip, Beveled Edge, 4 1/2"

MA781R

Epi Peeler, Semi Sharp, 4 1/2"

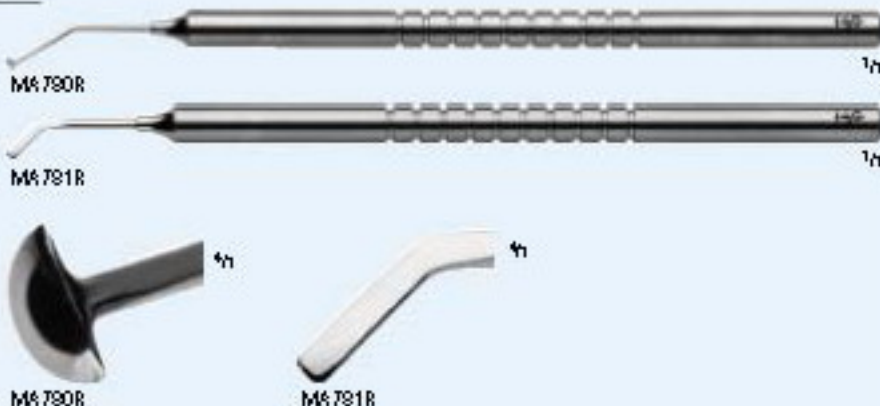

CHANG-SEIBEL Phaco Chopper

MA782R

Double Ended, Angled, C-Shaped Blunt Chopper and Vertical Safety Chopper, for Lefthand, 5 1/2"



KOCH Nucleus Spatula

MA783R

Gently Curved with 1 mm wide Duckbill Tip Smooth, 4 1/2"

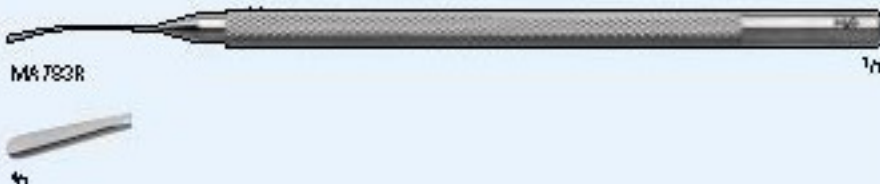

LIEBERMAN Nucleus Manipulator

MA784R

Angled, for Lefthand, 4 1/2"

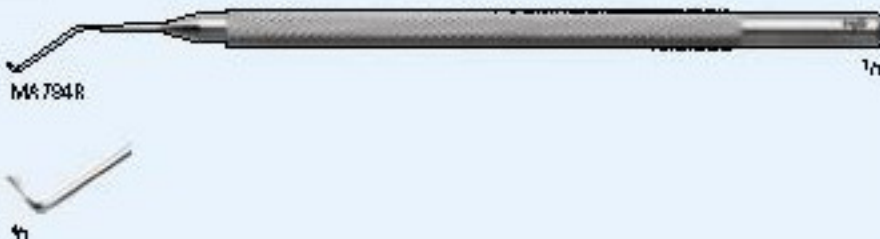

CHANG Combo Phaco Chopper

MA 785R

Double Ended, Angled, C-Shaped Blunt Chopper and 1.3 mm Sharp "QuickChop" Tip for Lefthand, 5 1/4"



NAGAHARA Nucleus Spatula

MA 786R

Angled, Flat Interior Edge, for Lefthand, 4 1/4"



BECHERT Nucleus Rotator

MA 789R

Angled 7 mm from Tip, "Y" Shaped Tip, 4 3/4"



JAFFE-BECHERT Nucleus Rotator

MA 790R

Angled 9 mm from Tip, "Y" Shaped Tip, 4 3/4"



DRYSDALE Nucleus Manipulator

MA791R

Paddle-shaped Tip, 4 1/4"

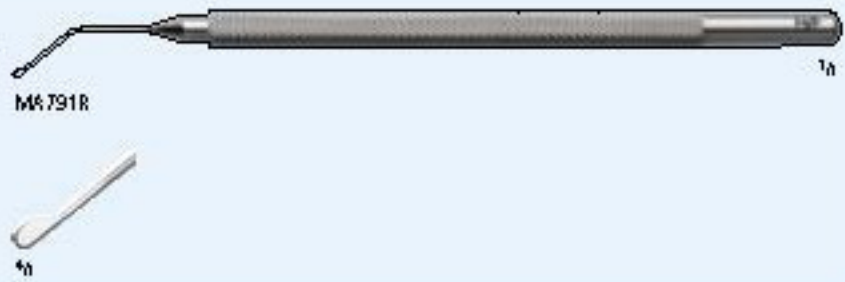

PISACANO Nucleus Rotator

MA792R

Vertical Flat Tip, 4 1/4"

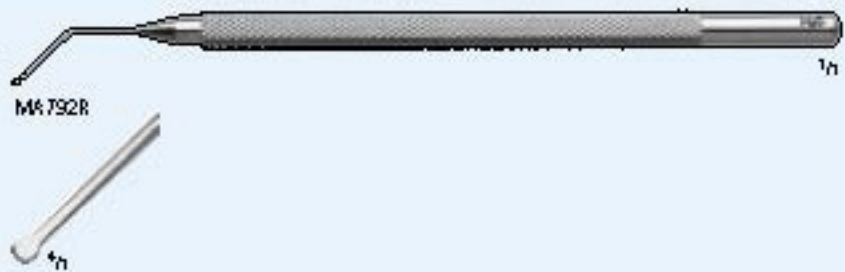

ANIS Wand Nucleus Manipulator

MA793R

Straight, 0.5 mm Ball-Shaped Tip, 4 3/4"



SIEBEL Flap Lifter and Spatula

MA794R

Double Ended, "Z"-Shaped Tip & 1.5 mm Angled Point, 4 1/8"



JAFFE Lens Spatula

MA795R

Flat, 0.5 mm wide Tip, 4 3/4"

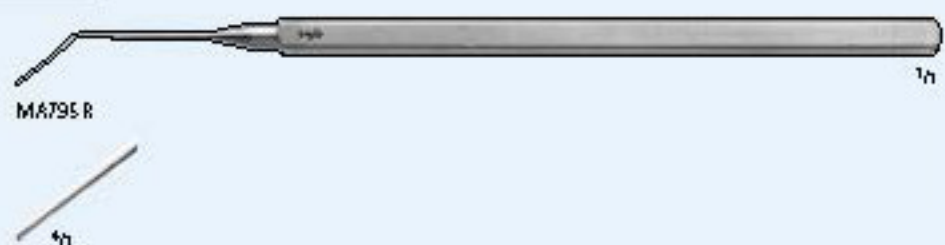

LESTER IOL Manipulator

MA776R

Straight, 0.25 mm Teardrop Shaped Tip, 4 1/2"

MA796R

Angled, 0.25 mm Teardrop Shaped Tip, 4 1/2"



MA796R



LESTER II IOL Manipulator

MA822T

Angled, 0.2 mm Teardrop Shaped Tip, Titanium, 4 1/2"



MA822T



MALONEY IOL Manipulator

MA797R

Curved, 0.25 mm Teardrop Shaped Tip, 4 1/2"



MA797R



BARRAQUER Cyclodialysis Spatula

MA637R

0.5 x 15 mm, Angled Blade, 47 $\frac{1}{2}$ "



CASTROVIEJO Cyclodialysis Spatula

MA799R

Double Ended, 10 x 0.5 mm Wide and
15 x 0.5 mm Wide, 5 $\frac{1}{4}$ "

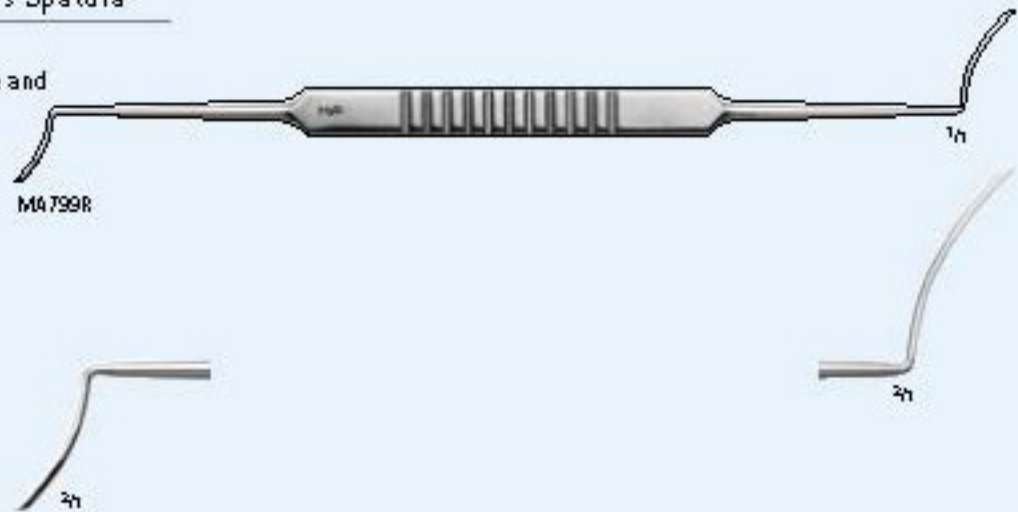

CASTROVIEJO Synechia Spatula

MA798R

Double Ended, 0.5 mm Wide, 5 $\frac{1}{4}$ "

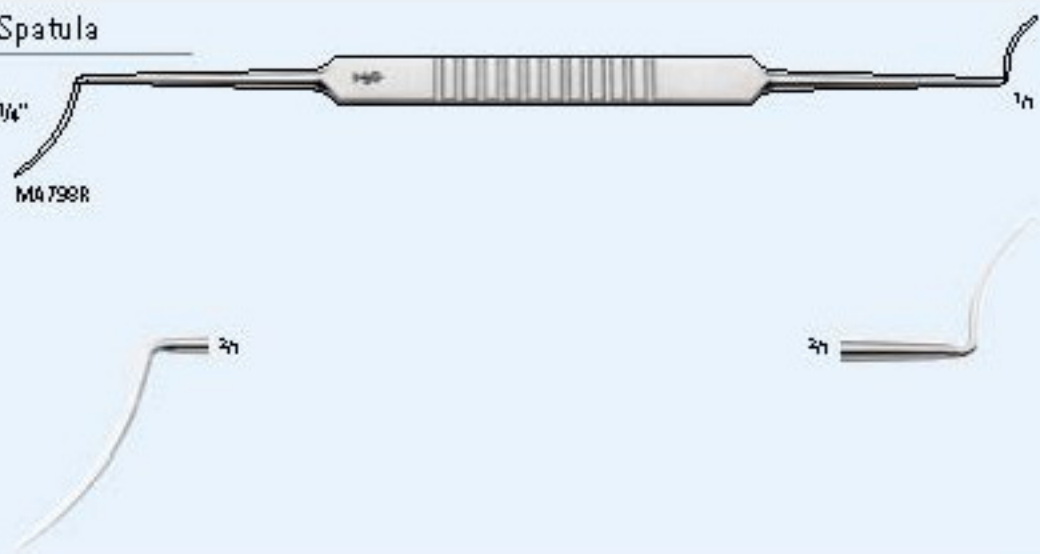

PATON Spatula and Spoon

MA 801R

Double Ended, 6 mm wide Grooved Spoon and
1.5 mm Flat Blade Angled at 8 mm, 5½"

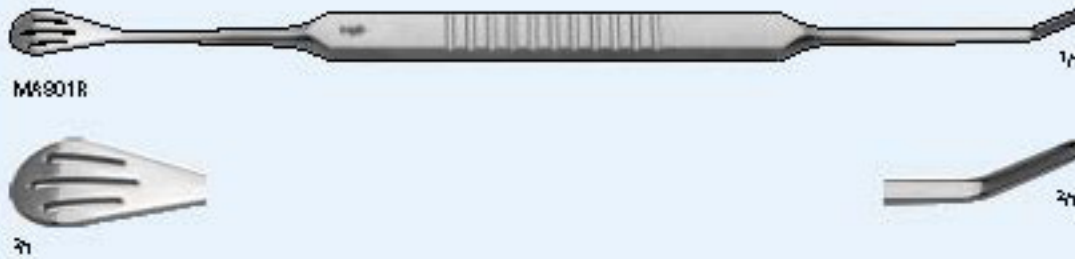

MA 801R

5½"

1h

2h

GRAETHER Collar Button

MA 803R

Angled 45°, 10 mm from Tip, 4¾"



MA 803R

4¾"

1h

CLAYMAN-JAFFE Lens Hook

MA 805R

Angled, 0.15 mm Blunt Tip, 4½"



MA 805R

4½"

1h

HARRS-SINSKEY Lens Manipulating Hook

MA 806R

Angled, 0.25 mm Blunt Tip, Flat Handle, 4½"



MA 806R

4½"

1h

SINSKEY Lens Manipulating Hooks

MA824R

Modified Curved Shaft, Flat Handle, 0.2 mm, 4 1/2"

MA804R

Angled, 0.2 mm Blunt Tip, Reversed, Flat Handle, 4 1/2"

MA630R

Straight, 0.25 mm Hook, Flat Handle, 4 5/8"

MA807R

Straight, 0.25 mm Blunt Tip, Round Handle, 4 1/2"

MA808R

Angled, 0.25 mm Blunt Tip, Round Handle, 4 1/2"

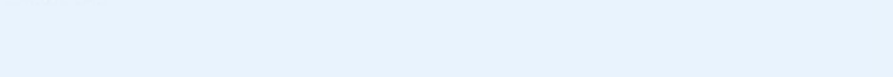
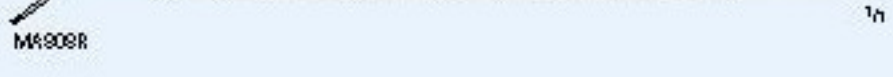
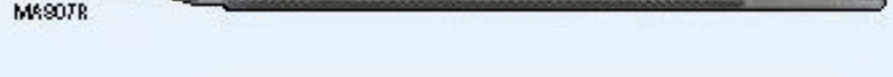
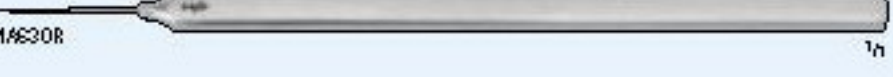
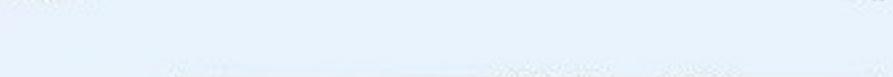
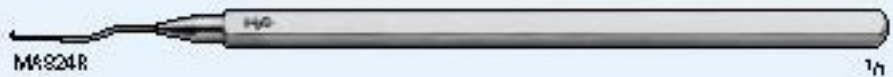
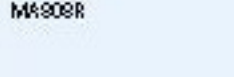
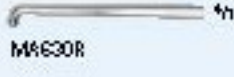

SINSKEY II Lens Manipulating Hooks

MA809R

Straight, 0.2 mm Blunt Tip, Flat Handle, 4½"

MA810R

Angled, 0.2 mm Blunt Tip, Flat Handle, 4½"

MA811R

Straight, 0.2 mm Blunt Tip, Round Handle, 4½"

MA812R

Angled, 0.2 mm Blunt Tip, Round Handle, 4½"

MA819T

Angled, 0.2 mm Blunt Tip, Round Handle,
Titanium, 4½"

MA825T

Straight, 0.2 mm Blunt Tip, Flat Handle, Titanium
4½"



MA809R & MA825T

h



MA810R

h



MA811R

h



MA819T

h



MA809R & MA825T

h



MA811R

h

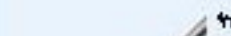

MA810R & MA812R

h

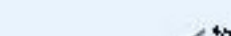

MA819T

h

KUGLEN Iris Hook and Lens Manipulators

MA631R

0.5 mm "K" Hook, Straight Shaft, 4 5/8"

MA813R

Straight, Push-pull Model, Flat Handle, 4 1/2"

MA814R

Angled, Push-pull Model, Flat Handle, 4 1/2"

MA815R

Straight, Push-pull Model, Round Handle, 4 1/2"

MA816R

Angled, Push-pull Model, Round Handle, 4 1/2"

MA827T

Straight, "K" Hook Model, Round Handle, Titanium, 4 1/2"

MA826T

Angled, Push-pull Model, Round Handle, Titanium, 4 1/2"

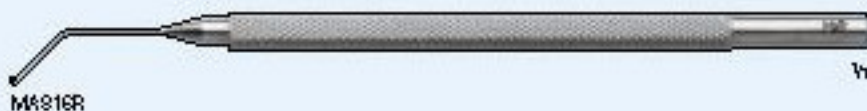
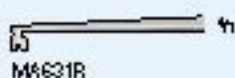



OSHER "Y" Hook Lens Manipulator

MA817R
Straight, 4½"



JAFFE-MALTZMAN Lens Manipulating Hook

MA818R
Angled, 0.15 mm Diameter "V" Shaped Tip, 4½"



MCPHERSON Iris Spatula

MA775R
16 x 1 mm, 4½"



KIRBY Hook & Muscle Loop

MA820R
Double Ended, 5 x 10 mm, 6½"



BONN Micro Iris Hook

MA821R
Straight, Blunt, 5"

JAMESON Muscle Hooks

MA632R

Small, 5 $\frac{3}{16}$ "

MA828R

Large, 1.7 mm Wide Tip, 10 mm, 4 $\frac{3}{4}$ "

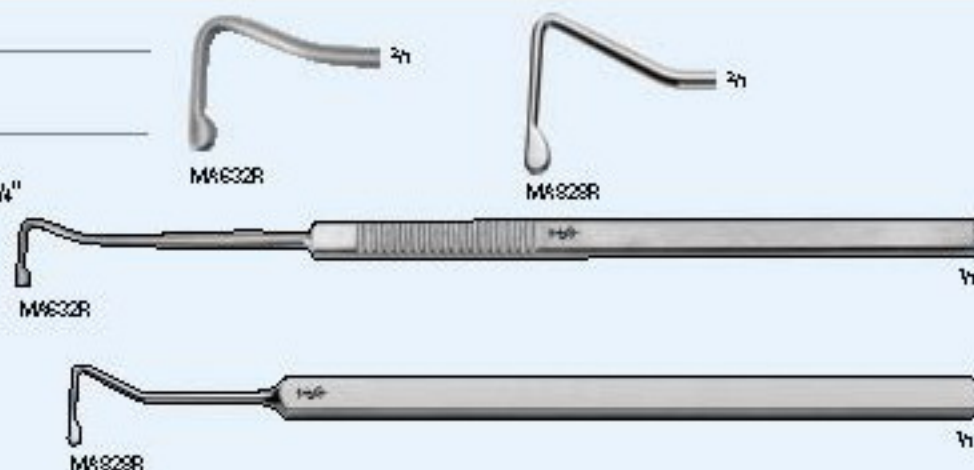

Green Strabismus Hook

MA633R

Flat, 8 mm Wide Hook, 5 $\frac{1}{8}$ "

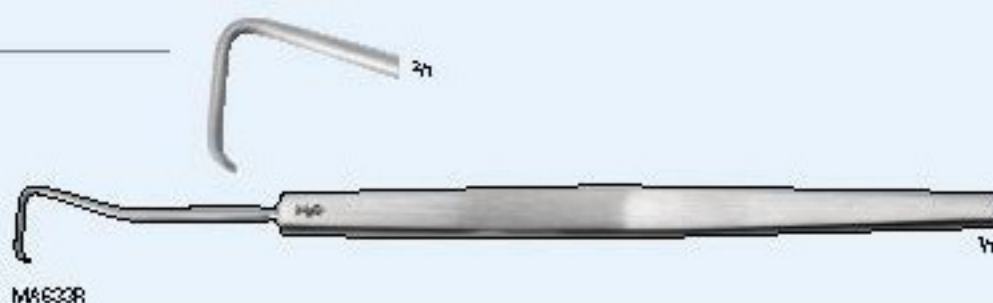

Twist Fixation Hook

MA634R

Right, Clockwise Twist, 4 $\frac{5}{16}$ "



GASS Retinal Detachment Hook

MA635R

5 $\frac{1}{8}$ "

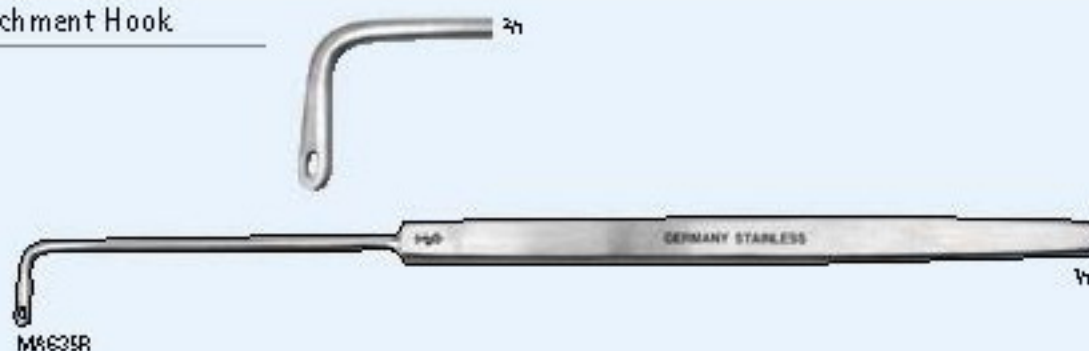

STEVENS Tenotomy Hook

MA636R

5 mm Curved Blunt Hook, 4 $\frac{5}{16}$ "

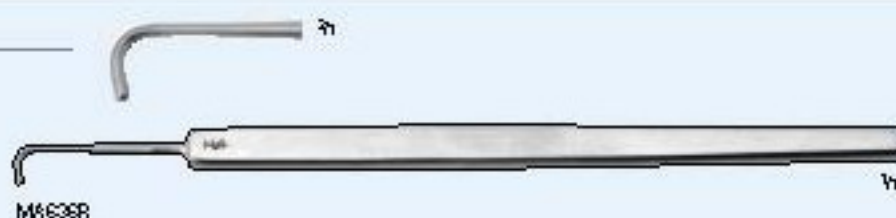



ALFONSO Nucleus Trisector

MA800R

1.5 mm Wide, 4 1/8"



MA800R



PIGTAIL Probes

MA971R

Blunt, 8 mm Diameter Pigtails, 6 1/8"

MA924R

Blunt, 8 mm Diameter Pigtails, Suture Holes, 5 1/8"

MA924R



MA971R & MA924R



NEW ORLEANS Lens Loop

MA823R

4 x 10 mm loop, 5 1/2"



MA823R

FLIERINGA Scleral Fixation Rings

MA732R

12 mm Diameter

MA733R

13 mm Diameter

MA734R

14 mm Diameter

MA735R

15 mm Diameter

MA736R

16 mm Diameter

MA737R

17 mm Diameter

MA738R

18 mm Diameter

MA739R

19 mm Diameter

MA740R

20 mm Diameter

MA741R

21 mm Diameter

MA742R

22 mm Diameter

MA743R

Set of 8, 15-22 mm Diameter



MA732R-MA743R

OSHER-NEUMANN Corneal Marker

MA975R

8 Blade, 4 1/8"



MA975R



THORNTON Swivel Fixation Ring

MA829R

13 mm Diameter, Blunt Teeth, 4 1/2"



MA829R



MA833R

MENDEZ Degree Gauge

MA833R
12 mm ID, Calibrated 100 from 0-180Q, 4 1/4"



MA834R

HENDERSON Degree Gauge

MA834R
Beveled Face, Smooth, For Use with MA837R, 4 1/8"



MA835R

HENDERSON Alignment Marker

MA835R
Blunt Pin Markings at 3, 6, & 9 O'Clock, For Use with MA834R & MA837R, 4"



MA836R

BORES Axis Marker

MA836R
For Use with MA833R, 4"



MA837R

HENDERSON Toric IOL Marker

MA837R
2.5 mm Axis Marks, for use with MA834R, 4"



MA838R - MA841R

BORES Optical Zone Markers

MA838R
3.5 mm ID, 4"

MA839R
6.0 mm ID, 4 1/8"

MA840R
7.0 mm ID, 4 1/8"

MA841R
8.0 mm ID, 4 1/8"



HOFFER Optical Zone Markers

- MA842R
4.25 mm ID, 4"

- MA843R
5.0 mm ID, 4"

- MA844R
5.5 mm ID, 4"

- MA845R
6.0 mm ID, 4"

- MA846R
8.0 mm ID, 4 1/8"

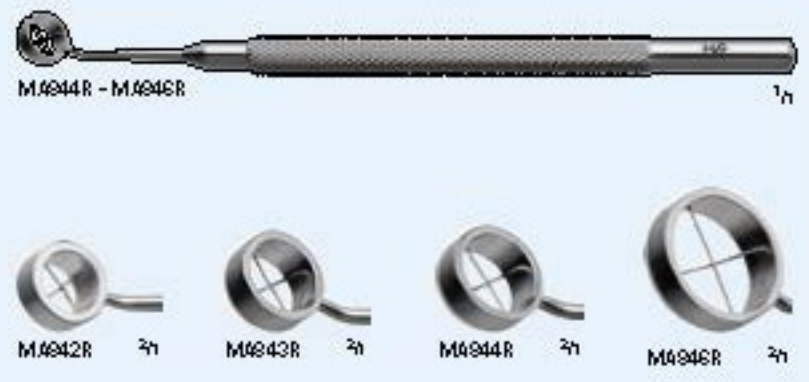

CASTROVIEJO Corneal Section Scissors

- MA850R
Right, Angled 9 mm Blade, Blunt Tips, 4 1/4"

- MA851R
Left, Angled 9 mm Blade, Blunt Tips, 4 1/4"

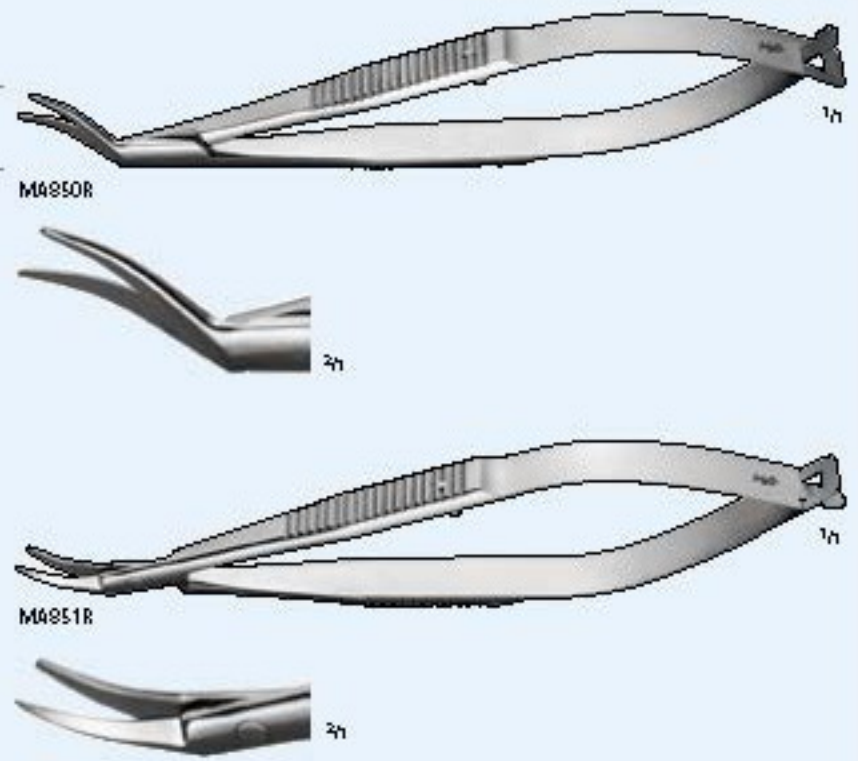



TROUTMAN Corneal Scissors

MA847R
Right, 10 mm Blade, 4 1/8"



CASTROVIEJO Corneal Scissors

MA848R
Curved Right, Small Blade, 4"

MA849R
Curved Left, Small Blade, 4"



TROUTMAN-CASTROVIEJO Corneal Scissors

MA852R
Curved Right, Medium Blade, Lock, 4 1/8"

MA853R
Curved Left, Medium Blade, Lock, 4 1/8"



TROUTMAN-KATZIN Corneal Scissors

MA854R
Strong Curved Right, Lock, 4 1/8"

MA855R
Strong Curved Left, Lock, 4 1/8"

CASTROVIEJO Universal Corneal Scissors

MA858R

Curved Blunt Tips, 16 mm from Mid-Screw, 4 3/4"

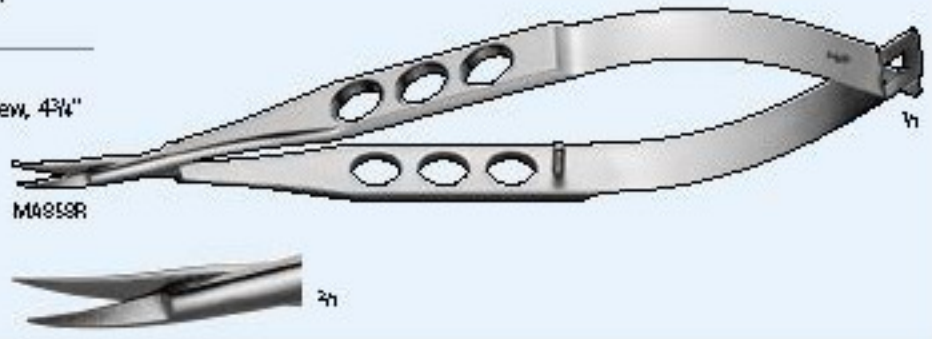

Micro Iris Scissors

MA873R

Curved Sharp Tips, 10 mm from Mid-Screw, 4 1/8"

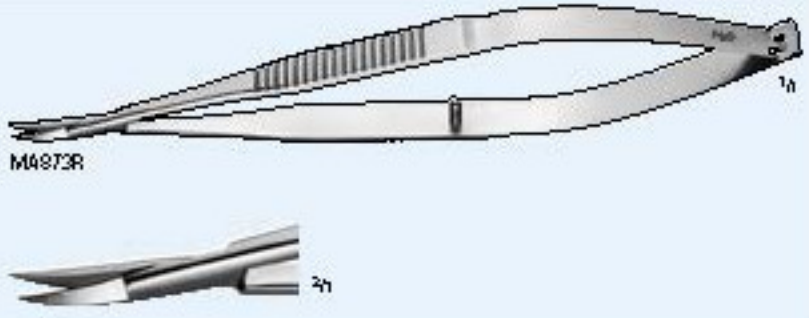

RICH Corneal Scissors

MA856R

Strong Curved Right, X-Delicate, 4 1/8"

MA857R

Strong Curved Left, X-Delicate, 4 1/8"

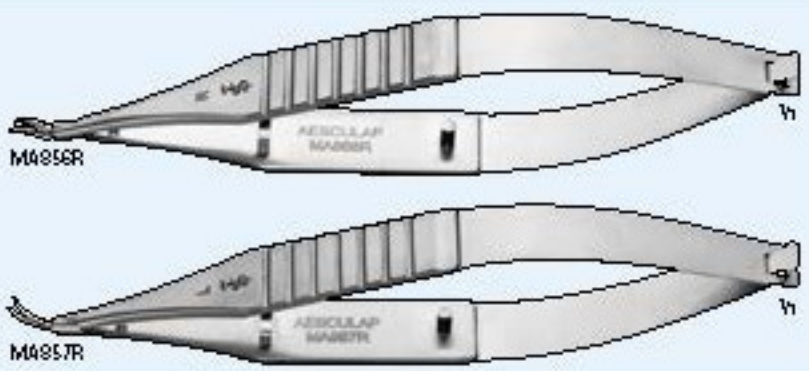

KATZIN Corneal Transplant Scissors

MA859R

Strong Curved Right, Medium Blade, 4 1/8"

MA860R

Strong Curved Left, Medium Blade, 4 1/8"

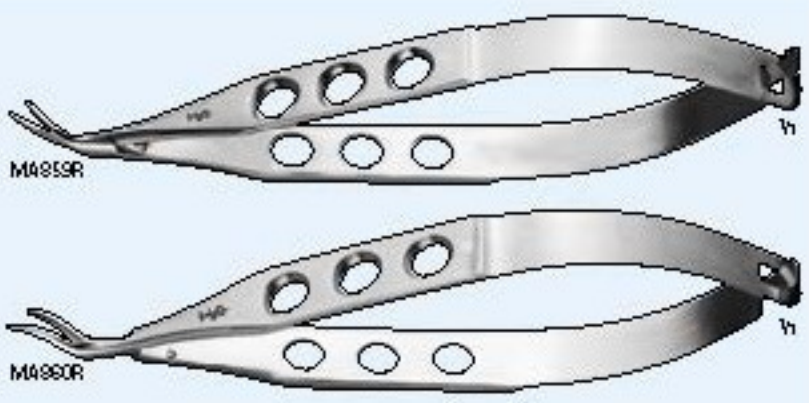



MA861R

BARRAQUER Iris Scissors

MA861R

Blunt, 8 mm Blade, 2 1/4"



MA862R

JAFFE Stitch Scissors

MA862R

X-Sharp, Curved, 4 3/4"



MA864R

FINE Stitch Scissors

MA864R

Sharp, Straight, 5 1/8"



MA865R

VANNAS Scissors

MA865R

Sharp, Curved, 10 mm Blades, 4 3/4"



MA866R

STERN-GILLS Scissors

MA866R

Sharp, X-Delicate, Straight Angled Forward,
10 mm Blades, 4 1/2"

URIBE-STERN Scissors

MA867R

Sharp, X-Delicate, Curved Angled Forward, 10 mm Blades, 4¾"



UTHOFF-GILLS Capsulotomy Scissors

MA868R

Blunt, Angled, Curved Tips, 10 mm, 4¾"



GILLS-WELSH VANNAS Scissors

MA870R

Sharp, 11 mm Blades, 3¼"



DEWECKER Iris Scissors

MA612R

Sharp and Blunt Tips, 4½"



VANNAS Capsulotomy Scissors

MA483R

Straight, 3¼"

MA484R

Curved, 3¼"

MA485R

Angled Down, 3¼"

MA486R

Angled Up, 3¼"

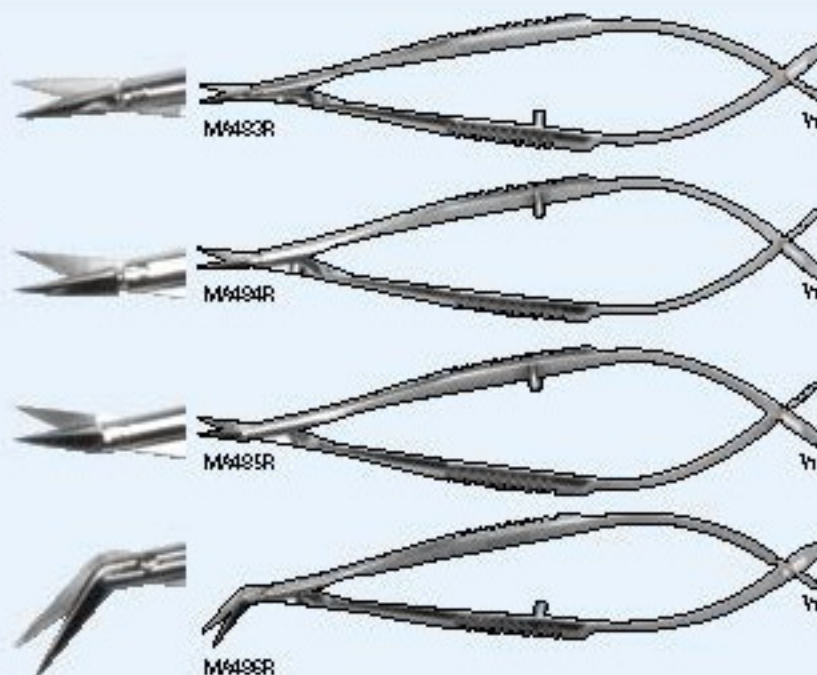



MA487R

WESTCOTT Stitch Scissors

MA487R
Sharp Point, 5 1/2"



MA613R

MA613R
Blunt Tips, Right, 4 3/4"



MA614R

MA614R
Blunt Tips, Left, 4 3/4"



FD100R- FD103R

Micro Scissors

FD100R
Round Handle, Straight, Sharp/Sharp, 5 3/4"



FD100R

FD101R

FD103R

FD101R
Round Handle, Curved, Sharp/Sharp, 5 3/4"



CC496R-CC497R

FD103R
Round Handle, Curved, Blunt/Blunt, 5 3/4"

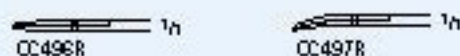

CC496R

CC497R

CC496R
Flat Handle, Straight, 4 1/8"

CC497R
Flat Handle, Curved, 4 1/8"



FD020R- FD021R

MILLESI Micro Scissors

FD020R
Flat Handle, Serrated, Straight, 6 1/4"

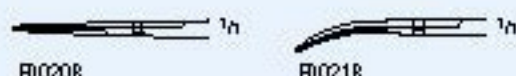

FD020R

FD021R

FD021R
Flat Handle, Serrated, Curved, 6 1/4"



CC480R

MCCLURE Micro Scissors

CC480R
Flat Handle, Straight, 3 3/4"



CC482R

NOYES Micro Scissors

CC482R
Flat Handle, Straight, 5"



CASTROVIEJO Scissors

OC485R

Flat Handle, Lat-Angled, 3¾"

OC486R

Flat Handle, Lat-Curved, 3¾"

OC491R

Flat Handle, Left-Curved, 4¾"

OC492R

Flat Handle, Right-Curved, 4¾"

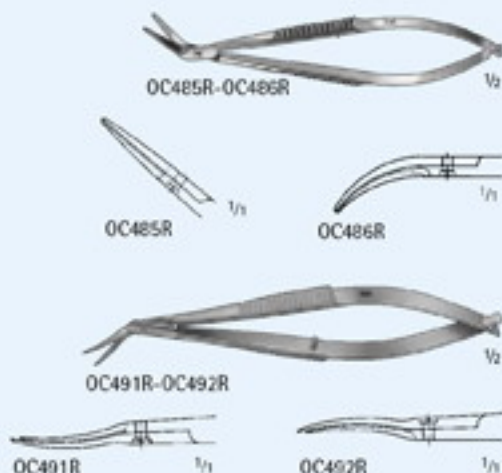

VANNAS Micro Scissors

OC498R

Flat Handle, Straight, 3¾"

OC499R

Flat Handle, Curved, 3¾"

OC500R

Flat Handle, Angled, 3¾"



Iris Scissors

BC004R

Square Handle, Straight, Sharp/Sharp, 4½"

BC005R

Square Handle, Curved, Sharp/Sharp, 4½"

BC050R

Delicate, Round Handle, Straight, Sharp/Sharp, 4¾"

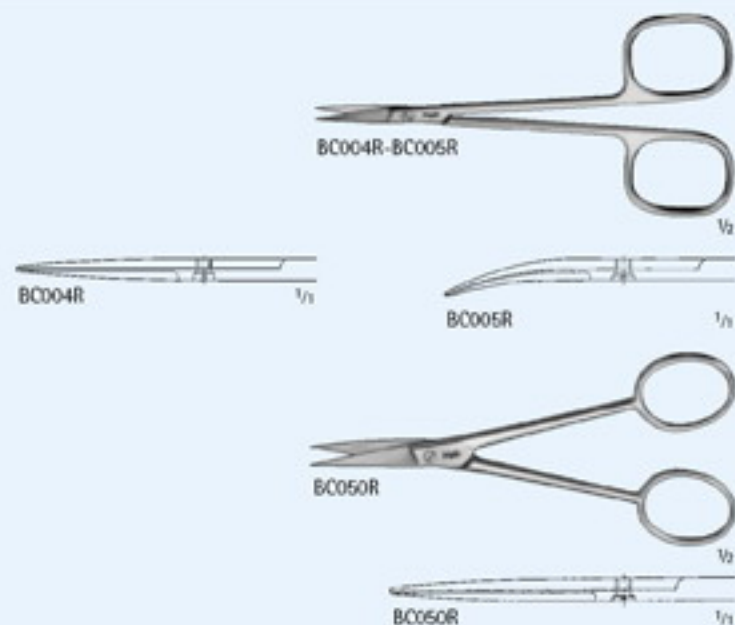

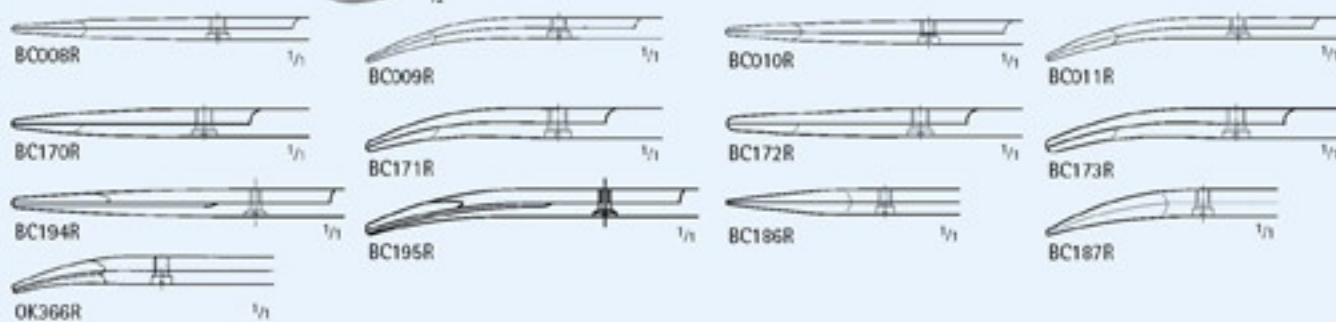
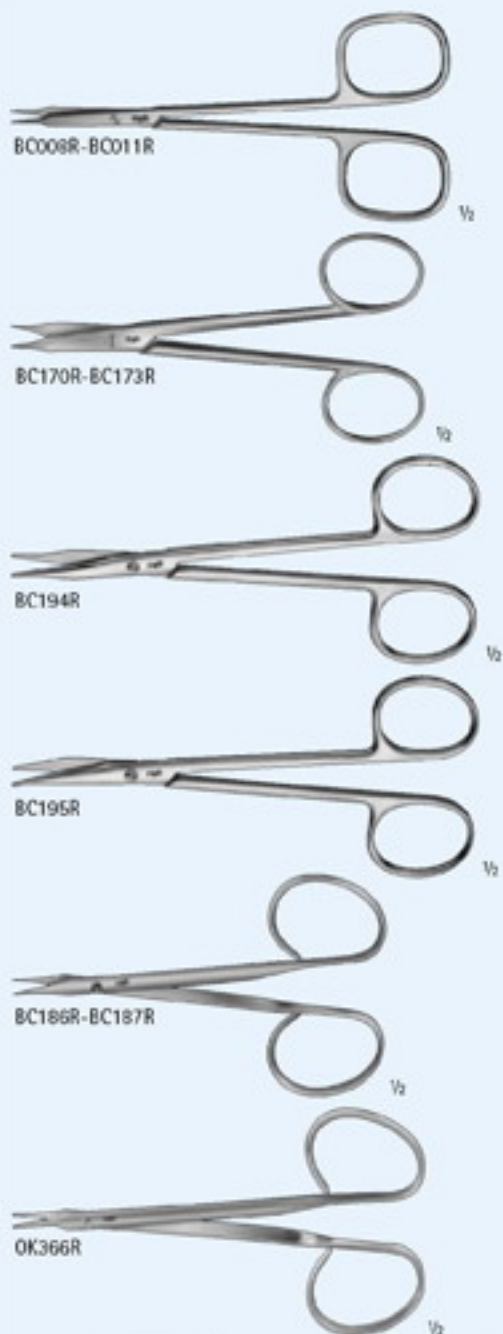

STEVENS Tenotomy Scissors

BC008R

Square Handle, Straight, Sharp/Sharp, 4½"

BC009R

Square Handle, Curved, Sharp/Sharp, 4½"

BC010R

Square Handle, Straight, Blunt/Blunt, 4½"

BC011R

Square Handle, Curved, Blunt/Blunt, 4½"

BC170R

Round Handle, Straight, Sharp/Sharp, 4¾"

BC171R

Round Handle, Curved, Sharp/Sharp, 4¾"

BC172R

Round Handle, Straight, Blunt/Blunt, 4¾"

BC173R

Round Handle, Curved, Blunt/Blunt, 4¾"

BC194R

Fine, Round Handle, Straight, Blunt/Blunt, 5"

BC195R

Fine, Round Handle, Curved, Blunt/Blunt, 5"

BC186R

Ribbon Handle, Straight, Sharp/Sharp, 4"

BC187R

Ribbon Handle, Curved, Sharp/Sharp, 4"

OK366R

Ribbon Handle, Curved, Blunt/Blunt, 4¾"

Strabismus Scissors

BC020R

Delicate, Square Handle, Straight, Blunt/Blunt, 4½"

BC021R

Delicate, Square Handle, Curved, Blunt/Blunt, 4½"

BC164R

Delicate, Round Handle, Straight, Blunt/Blunt, 4½"

BC165R

Delicate, Round Handle, Curved, Blunt/Blunt, 4½"

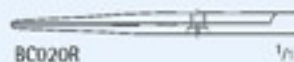

BC020R

1/4"



BC021R

1/4"



BC164R

1/4"



BC165R

1/4"

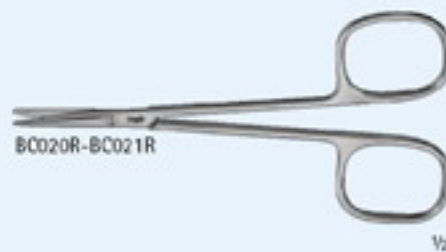

BC020R-BC021R

1/2"



BC164R-BC165R

1/2"

Iris Scissors, Durotip

BC210R

TC, Straight, Sharp/Sharp, 4¾"

BC211R

TC, Curved, Sharp/Sharp, 4¾"

BC211W

TC, Serrated, Curved, Sharp/Sharp, 4¾"



BC210R

1/4"



BC211R

1/4"



BC211W

1/4"

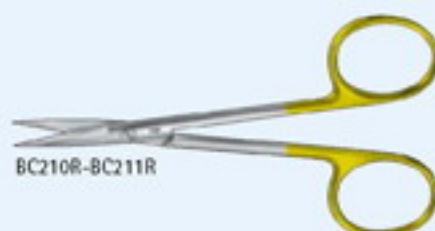

BC210R-BC211R

1/2"



BC211W

1/2"

Strabismus Scissors, Durotip

BC256R

TC, Straight, Blunt/Blunt, 4½"

BC257R

TC, Curved, Blunt/Blunt, 4½"

BC257W

TC, Serrated, Curved, Blunt/Blunt, 4½"



BC256R

1/4"



BC257R

1/4"



BC257W

1/4"

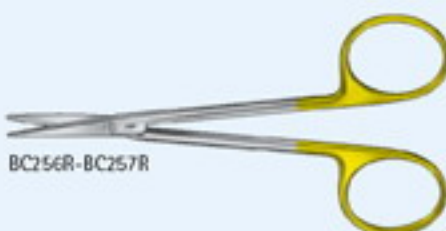

BC256R-BC257R

1/2"



BC257W

1/2"

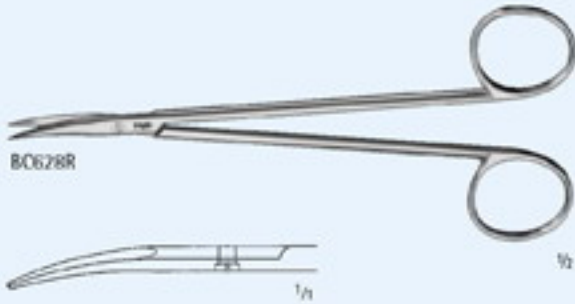

Nerve Scissors

BC628R

Curved, Sharp/Sharp, 6"



Enucleation Scissors

OC430R

Curved, 5"

MA874R

Full Curved, Heavy, 5 1/8"



Eye Scissors

MA475R

Blunt Probe Tips, Angled, 4 1/2"

Utility Scissors

MA476R

Ribbon Handle, Straight, Blunt, 4"

MA477R

Ribbon Handle, Curved, Blunt, 4"

MA478R

Ribbon Handle, Curved, Flat, 3 3/4"

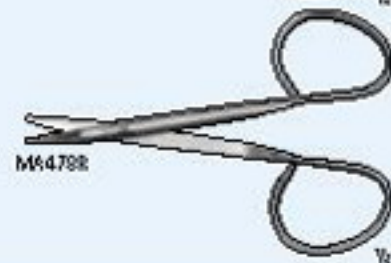
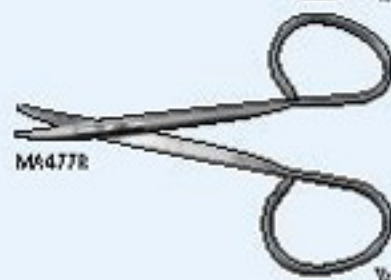
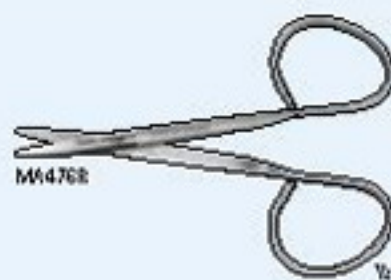

Stitch Scissors

MA479R

Ribbon Handle, Curved, Flat, 3 3/4"

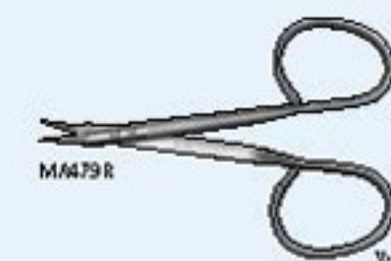

Stitch Removal Scissors

MA480R

4 3/4"

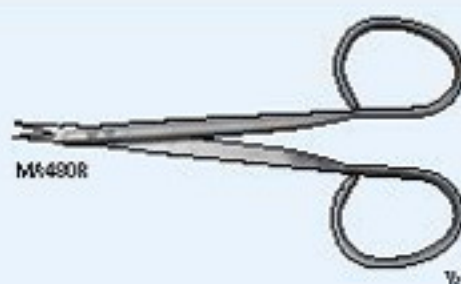



WILMER Conjunctival Scissors

MA871R

Angled-Flat, 17 mm, 4 1/8"

Forceps

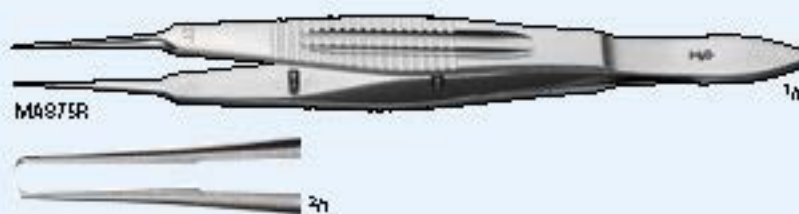

OSHER-ELSCHNIG Forceps

MA875R

1 x 2 Teeth, 3 mm x 0.12 Tying Platform, 4 1/8"

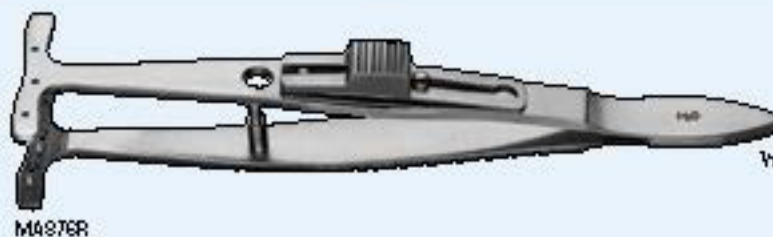

PUTTERMAN-Type Muscle Forceps

MA876R

Serrated, 6 Pins, Lock, 4"



TENNANT Tying Forceps

MA886R

Straight, Extra Delicate, Smooth Jaws, 6 mm Platform, 4 1/4"



AKAHOSHI Combo Prechopper

MA888R

Straight, 4.5 mm Tips, Cross-Action, 4 1/4"

SINSKEY Tying Forceps

MA885R

X-Delicate, Smooth, Curved, 4"

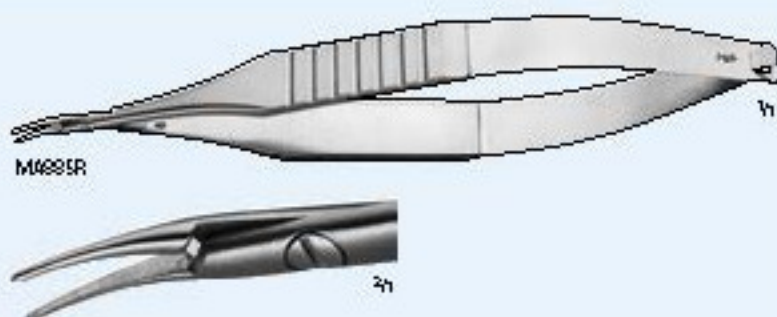

SHEPARD Lens Holding Forceps

MA891R

Curved, Duckbill Jaws, X-Action, 5"

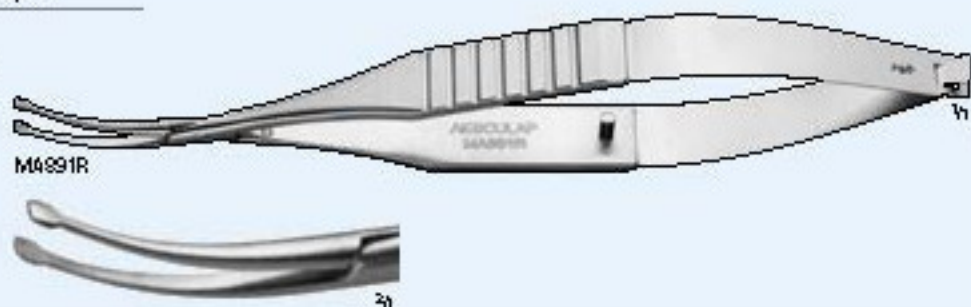

CLAYMAN Lens Holding Forceps

MA892R

Curved, Delicate Angled Jaws, X-Action, 4 3/4"



SCLERAL Plug Forceps

MA896R

Curved Angled, 9 mm Jaws, X-Action, 4 1/8"

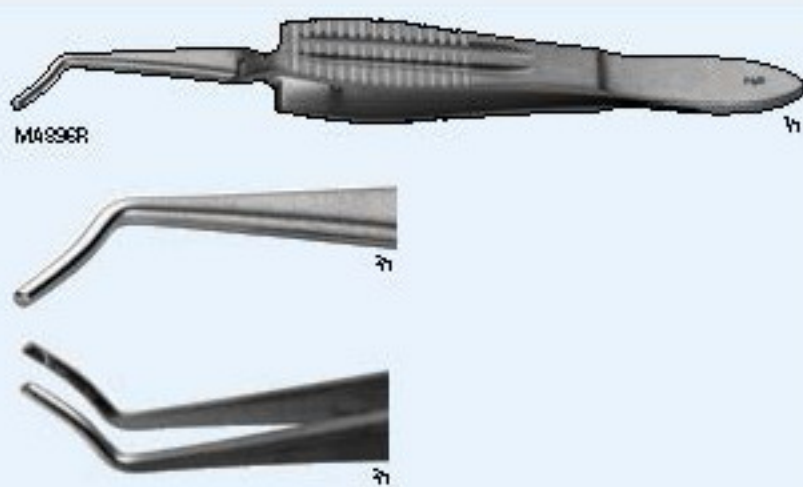

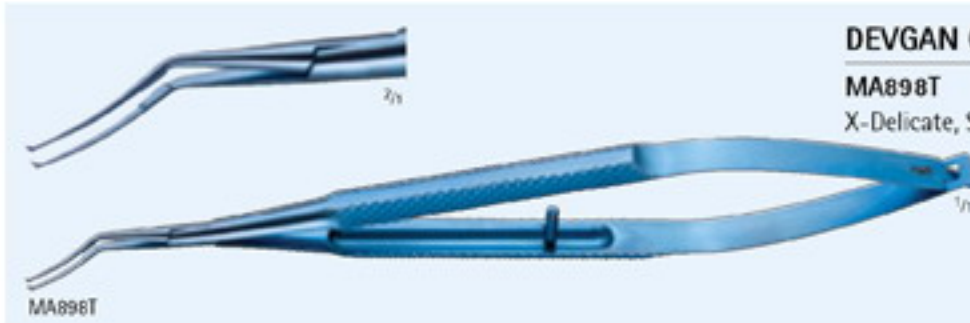

DEVGAN Capsulorhexis Forceps

MA898T

X-Delicate, Semi-sharp tips, 5"

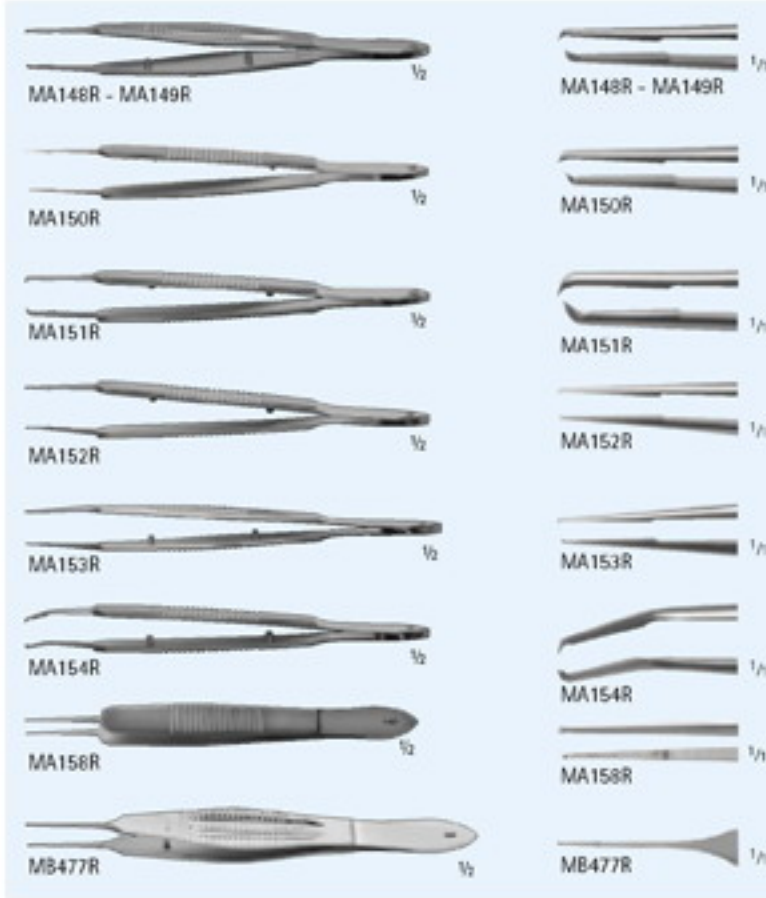

CASTROVIEJO Suture Forceps

MA148R

0.5 mm, 1 x 2 Teeth, with Tying Platform, Wide Handle, 4 1/4"

MA149R

1.5 mm, 1 x 2 Teeth, with Tying Platform, 4 1/4"

MA150R

0.5 mm, 1 x 2 Teeth, with Tying Platform, 4 1/4"

MA151R

0.9 mm, 1 x 2 Teeth, with Tying Platform, 4 1/4"

MA152R

0.22 mm, 1 x 2 Teeth, with Tying Platform, 4 1/4"

MA153R

0.12 mm, 1 x 2 Teeth, with Tying Platform, 4 3/8"

MA154R

0.5 mm, Angled 45° 1 x 2 Teeth, with Tying Platform, 4 1/4"

MA158R

0.3 mm Tip, 1 x 2 Teeth, with Tying Platform, 4 1/2"

MB477R

0.3 mm, 1 x 2 Teeth, with Tying Platform, Wide Handle, 4 3/8"



CASTROVIEJO Tissue Forceps

OC094R

Delicate, 1 x 2 Teeth 0.5 mm, 4"



CASTROVIEJO Cross Action

MA618R

10 mm from Angle to Tip, 4 1/8"

BONN Suture Forceps

MA155R

0.12 mm, 1 x 2 Teeth, Platform, 3³/₄"



BONN Tissue Forceps

MA878R

1 x 2 Teeth, 0.12 mm, 3"



THORPE Conjunctival Fixation Forceps

MA157R

2 x 3 Teeth, 3³/₄"



THORPE Corneal Forceps

MA901R

Straight, 45°, 0.12 mm, 2 x 3 Teeth, 3³/₄"



LESTER Fixation Forceps

MA166R

Fine 1 x 2 Teeth, 3³/₄"

MA167R

Fine 2 x 3 Teeth, 3³/₄"

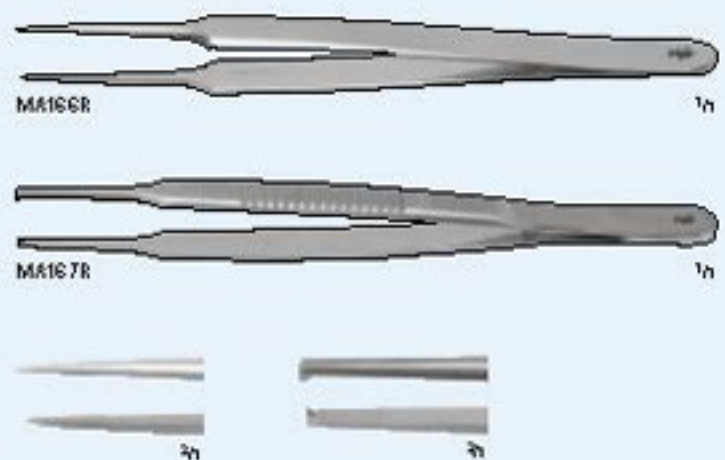

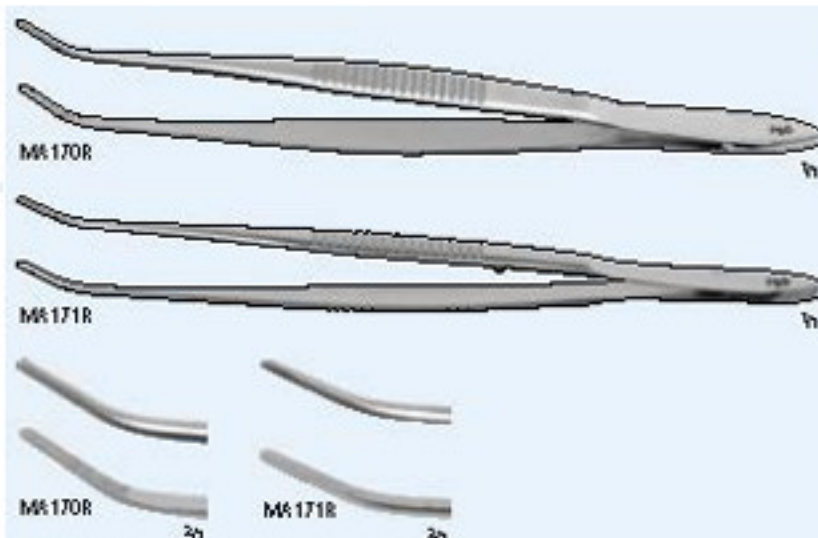

NUGENT Utility Forceps

- MA 170R
Serrated, Angled 45°, 10 mm Jaw, 4 1/4"

- MA 171R
Smooth, Angled 45°, 10 mm Jaw, 4 1/4"

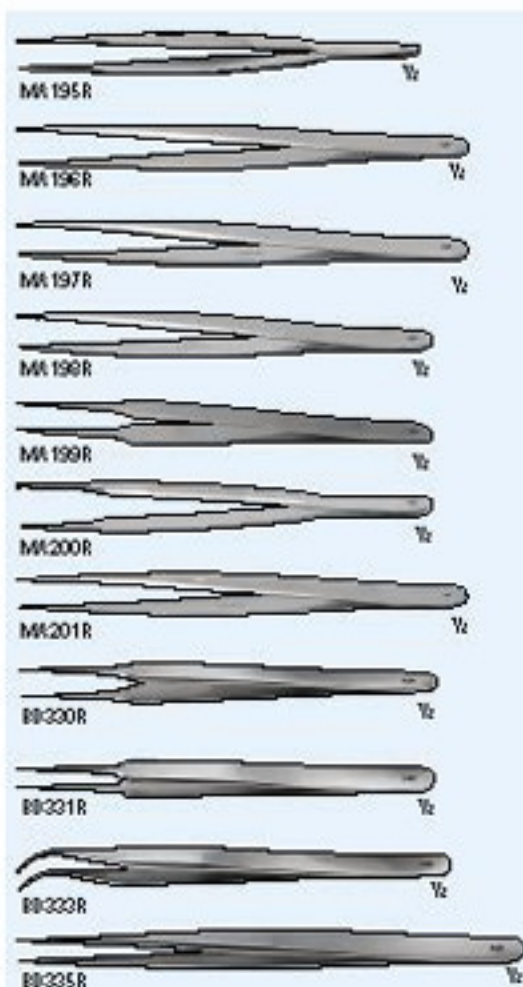

JEWELERS Micro Forceps

- MA 195R
3 mm Platform, 4 1/4"

- MA 196R
#1, Fine, 6 mm Tying Platform, 4 3/4"

- MA 197R
#3, Extra Fine, 5 mm Tying Platform, 4 3/4"

- MA 198R
#3, Extra Fine, 5 mm Tying Platform, 4 3/4"

- MA 199R
#4, Extra Fine, 6 mm Tying Platform, 4 3/4"

- MA 200R
#5, Extra Fine, 6 mm Tying Platform, 4 3/4"

- MA 201R
#1, Fine, 4 3/4"

- BD 330R
#4, 0.20 mm Tip, 4 3/4"

- BD 331R
#5, 0.15 mm Tip, 4 3/4"

- BD 333R
#7, Curved, 0.20 mm Tip, 4 3/4"

- BD 335R
#3, 0.30 mm Tip, 4 1/2"

BERKE Ptosis Forceps

MA316R

20 mm Jaw, 4"

MA317R

27 mm Jaw, 4 1/2"



Serrefine

MA548R

10 mm Serrated Jaws, 1 3/8"



LEHNER-UTRATA Capsulotomy Forceps

MA881R

Curved, 12 mm Angled Tips, Flat Handle, 3 1/2"

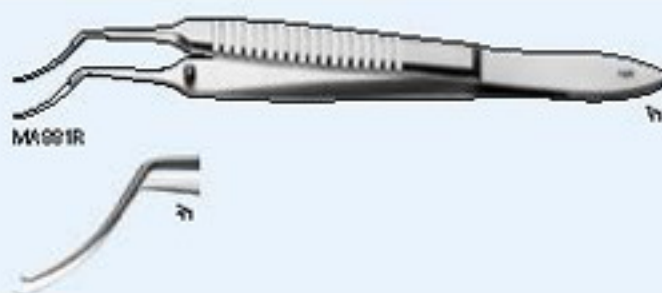

UTRATA Capsulorhexis Forceps

MA617R

12 mm Angled Tips, 3 1/2"



CORNEAL COLIBRI Style Forceps

MA619R

1 x 2 Teeth, 50° with 6 mm Tying Platform, 4 3/16"



TROUTMAN BARRAQUER Corneal Forceps

MA620R

0.12 mm, 1 x 2 Teeth, 2 3/8"

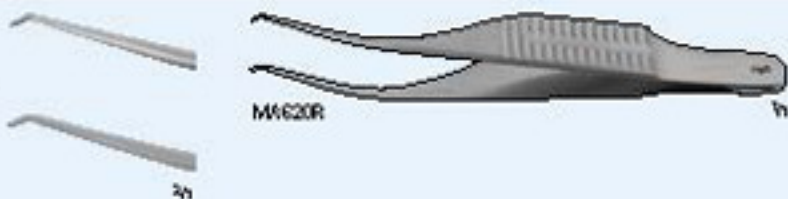



COLIBRI Forceps

MA897T

0.12 mm, 1x2 Teeth, Titanium, 3"



MCPHERSON Angled Corneal Suturing Forceps

MA621R

1 x 2 Teeth, Angled, 45° with 5 mm Tying Platform, 3%



BRACKEN Curved Iris Forceps

MA622R

Curved, Cross Serrated Tips, 3%



KELLMAN-MCPHERSON Forceps

MA624R

Angled 45°, 8.5 mm Tying Platform, 3¼"



MCPHERSON Forceps

MA625R

Straight 5 mm Tying Platform, 3¼"

BECHERT-MCPHERSON Forceps

MA879R

Angled, 10 mm tips, 3 1/4"

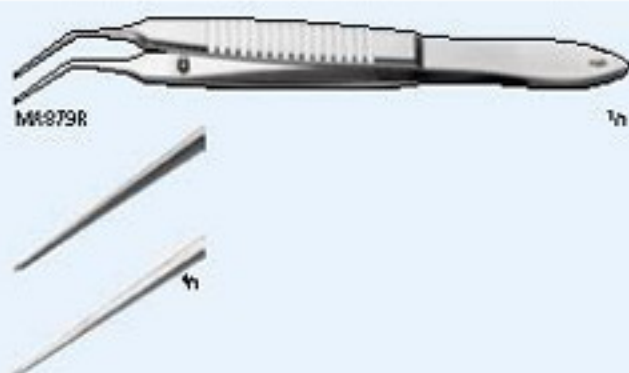

SHEETS-MCPHERSON Forceps

MA880R

Angled, 10 mm, 1 mm Cross-toothed Tips, 3 1/4"

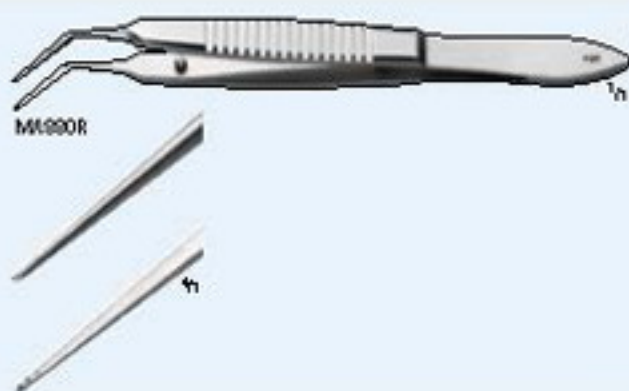

JAMESON Muscle Forceps

MA626R

Left, 12 mm Angled Jaws, 3 3/8"

MA726R

Right, 12 mm Angled Jaws, 4"

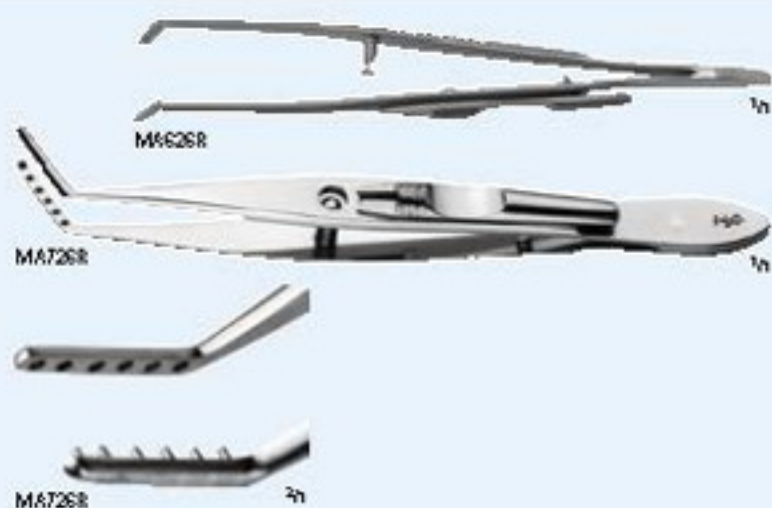

MCCULLOUGH Utility Forceps

MA623R

Smooth Jaw, Straight, 15 mm, 3 5/8"



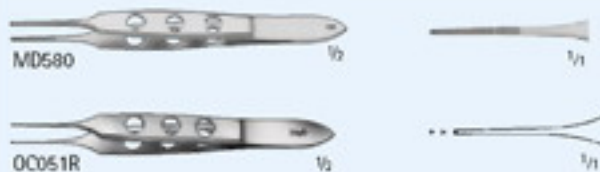

BISHOP HARMON Iris Forceps

MD580

Without Teeth, Serrated, 3 1/2"

OC051R

1 x 2 Teeth, 3 1/2"

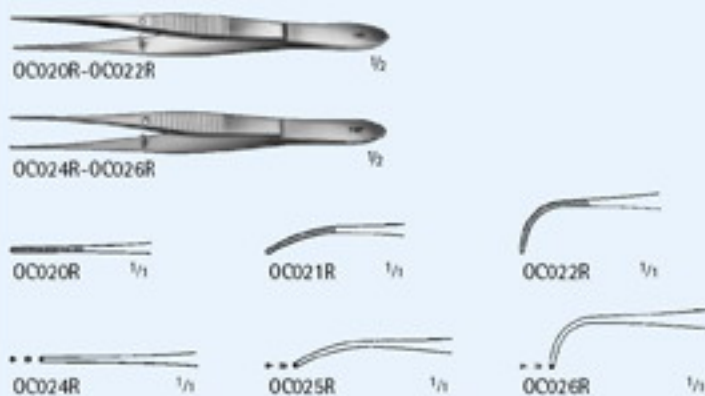

Iris Forceps

OC020R

Delicate, Serrated, Straight, 4"

OC021R

Delicate, Serrated, Curved, 4"

OC022R

Delicate, Serrated, Heavy Curved, 4"

OC024R

X-Fine, 1 x 2 Teeth, Straight, 4"

OC025R

X-Fine, 1 x 2 Teeth, Curved, 4"

OC026R

X-Fine, 1 x 2 Teeth, Heavy Curved, 4"



ST MARTIN Tissue Forceps

OC091R

Delicate, 1 x 2 Teeth, 3 1/8"



GRAEFE Tissue Forceps

OC100R

4 1/2"



Tying Forceps

MA899R

Straight, 4 1/4"



ALABAMA UNIVERSITY Forceps

MA900R

Straight, 15 mm V-Grooved Platform, 3 1/2"



TROUTMAN Superior Rectus Forceps

MA902R

1 x 2 Teeth, 10 mm, Angled, 4 1/8"

BARRAQUER Micro Needle Holder

BM560R

Round Handle, Curved, Smooth, without Catch, 4½"

BM562R

Round Handle, Curved, Delicate Smooth, without Catch, 4¾"

FD230R

Round Handle, Straight, Smooth, without Catch, 4¾"

FD232R

Round Handle, Straight, Smooth, with Catch, 4¾"

FD231R

Round Handle, Curved, Smooth, without Catch, 4¾"

FD233R

Round Handle, Curved, Smooth, with Catch, 4¾"

MA351R

Round Knurled Handle, Straight, with Catch, 5¼"

MA352R

Round Knurled Handle, Straight, without Catch, 5¼"

MA357R

Round Knurled Handle, Curved, without Catch, 5¼"

MA358R

Round Knurled Handle, Curved, with Catch, 5¼"

MA360R

Round Knurled Handle, Curved, without Catch, 4¾"

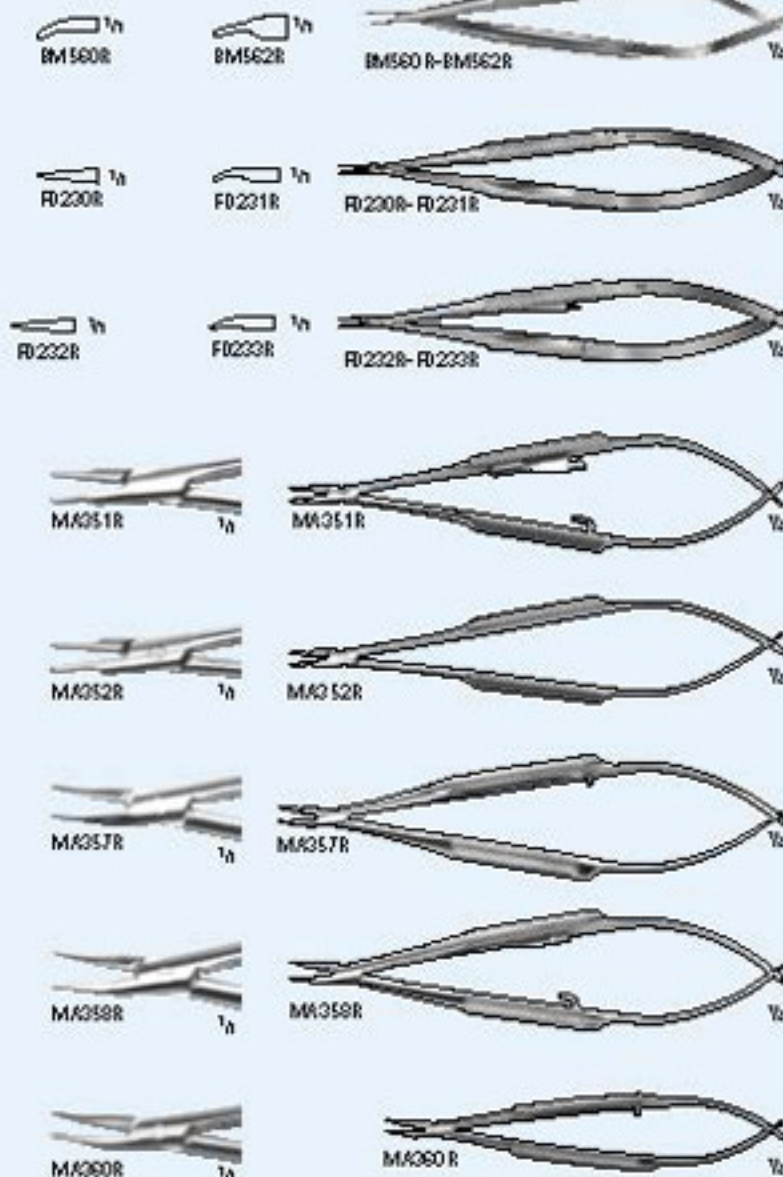

COHEN Micro Needle Holder

MA353R

Round Knurled Handle, Curved, without Catch, 4¾"

MA354R

Round Knurled Handle, Curved, with Catch, 4¾"





TROUTMAN Micro Needle Holder

MA355R

Flat Handle, Curved, with Catch, 4 1/4"

MA356R

Flat Handle, Curved, 9 mm Jaw, with Catch, 5 1/2"

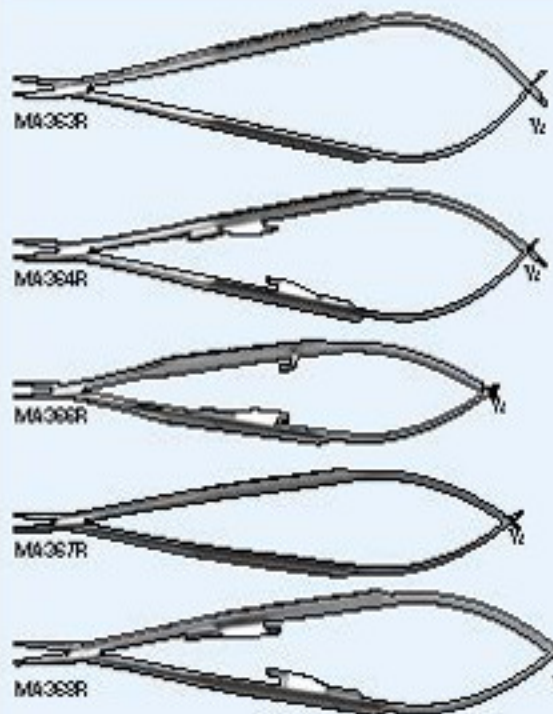

CASTROVIEJO Micro Needle Holder

MA363R

Flat Handle, Curved, 10 mm Jaw, without Catch, 5 5/8"

MA364R

Flat Handle, Straight, 10 mm Jaw, with Catch, 5 5/8"

MA366R

Flat Handle, Straight, 9 mm Jaw, with Catch, 5 1/2"

MA367R

Flat Handle, Straight, 10 mm Jaw, without Catch, 5 3/8"

MA368R

Flat Handle, Straight, 16 mm Jaw, with Catch, 5 7/8"

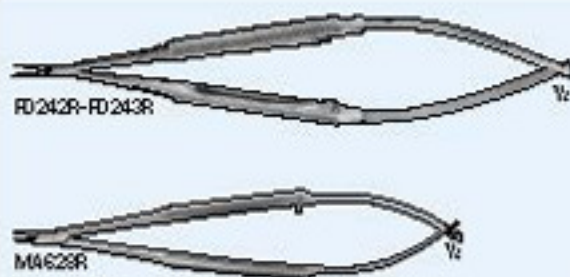

Micro Needle Holder

FD242R

Round Handle, Straight, Smooth, with Catch, 6"

FD243R

Round Handle, Curved, Smooth, with Catch, 6"

MA628R

Delicate Jaws Curved without Lock, Knurled Handle, 4 3/4"



HAMPTON Micro Needle Holder

MA907R

Heavy Jaw, Curved, with Catch, 5 1/2"

MCPHERSON Micro Needle Holder

MA908R

Flat Handle, Delicate, Straight, with Catch, 4 3/4"

MA909R

Flat Handle, Delicate, Straight, without Catch, 4 3/4"

MA910R

Flat Handle, Delicate, Curved, with Catch, 4 3/4"

MA911R

Flat Handle, Delicate, Curved, without catch, 4 3/4"

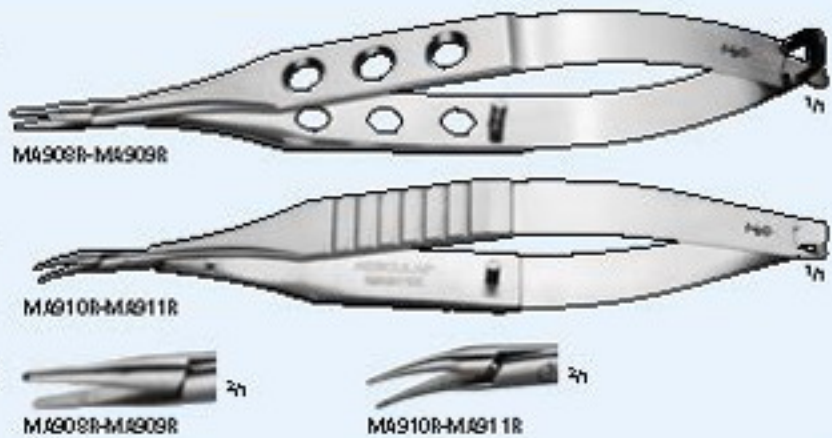

BROWN Needle Holder

MA362R

Serrated, 13 mm Jam, 5 1/2"

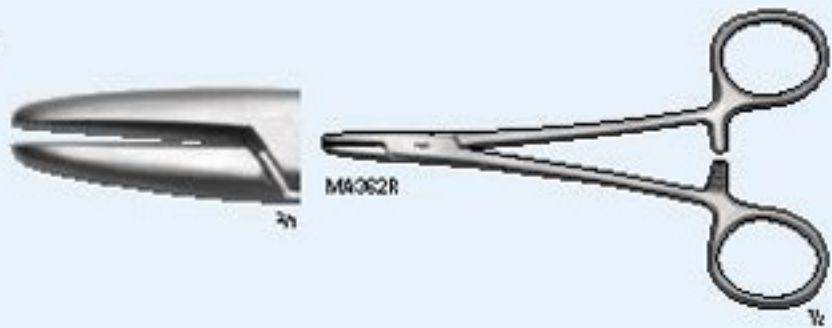

CASTROVIEJO Lacrimal Dilator

MA921R

Double Ended, Fine and Medium Taper, 4 3/4"



RUEDEMANN Lacrimal Dilator

MA917R

12 mm, 2 3/4"



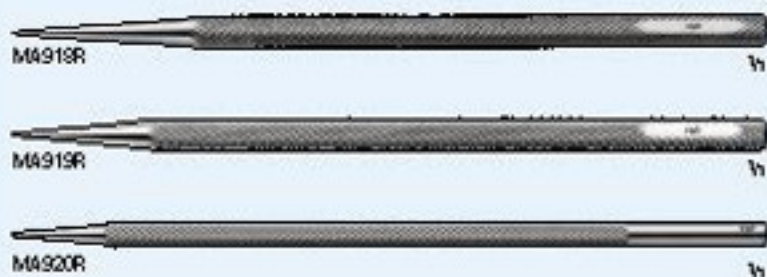

WILDER Lacrimal Dilators

- MA918R
Long Taper, 23 mm, 4"

- MA919R
Medium Taper, 18 mm, 4"

- MA920R
Short Taper, 13 mm, 4"



WILLIAMS Lacrimal Probes

- MA410R
#00/0, 5 1/2"

- MA411R
#1/2, 5 1/2"

- MA412R
#3/4, 5 1/2"

- MA413R
#5/8, 5 1/2"

- MA414R
#7/8, 5 1/2"

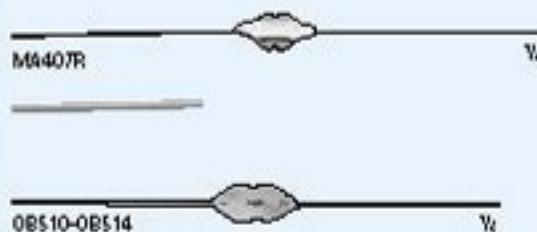

BOWMAN Lacrimal Probes

- MA407R
#0000/000, 5 1/2"

- OB510
00/0, 5 1/2"

- OB511
1/2, 5 1/2"

- OB512
3/4, 5 1/2"

- OB513
5/8, 5 1/2"

- OB514
7/8, 5 1/2"

CATALANO Lacrimal Intubation Set

MA915R

Two 0.7 mm Probes Attached to 250 mm Long
Silicone Tubing (Single-Use)

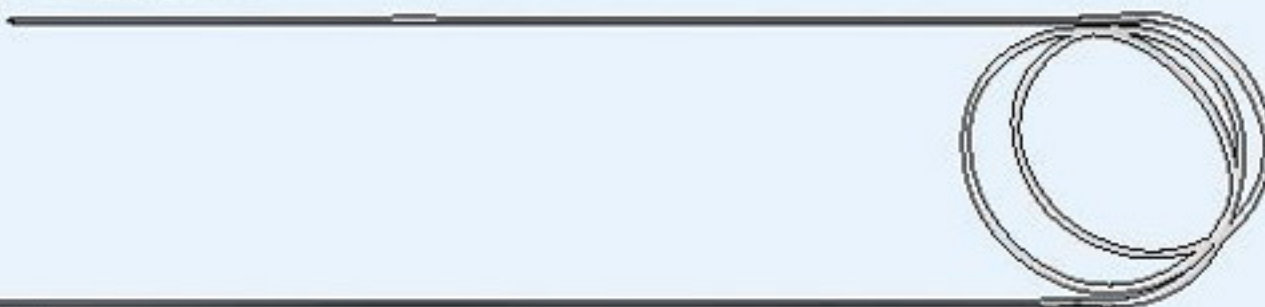

MA915R

JACKSON Lacrimal Intubation Set

MA916R

Two 0.9 mm Probes Attached to 250 mm Long
Silicone Tubing (Single-Use)



MA916R

CRAWFORD Lacrimal Intubation Set

MA922R

Two Olive-tipped 0.8 mm Probes Attached to
250 mm Long Silicone Tubing (Single-Use)

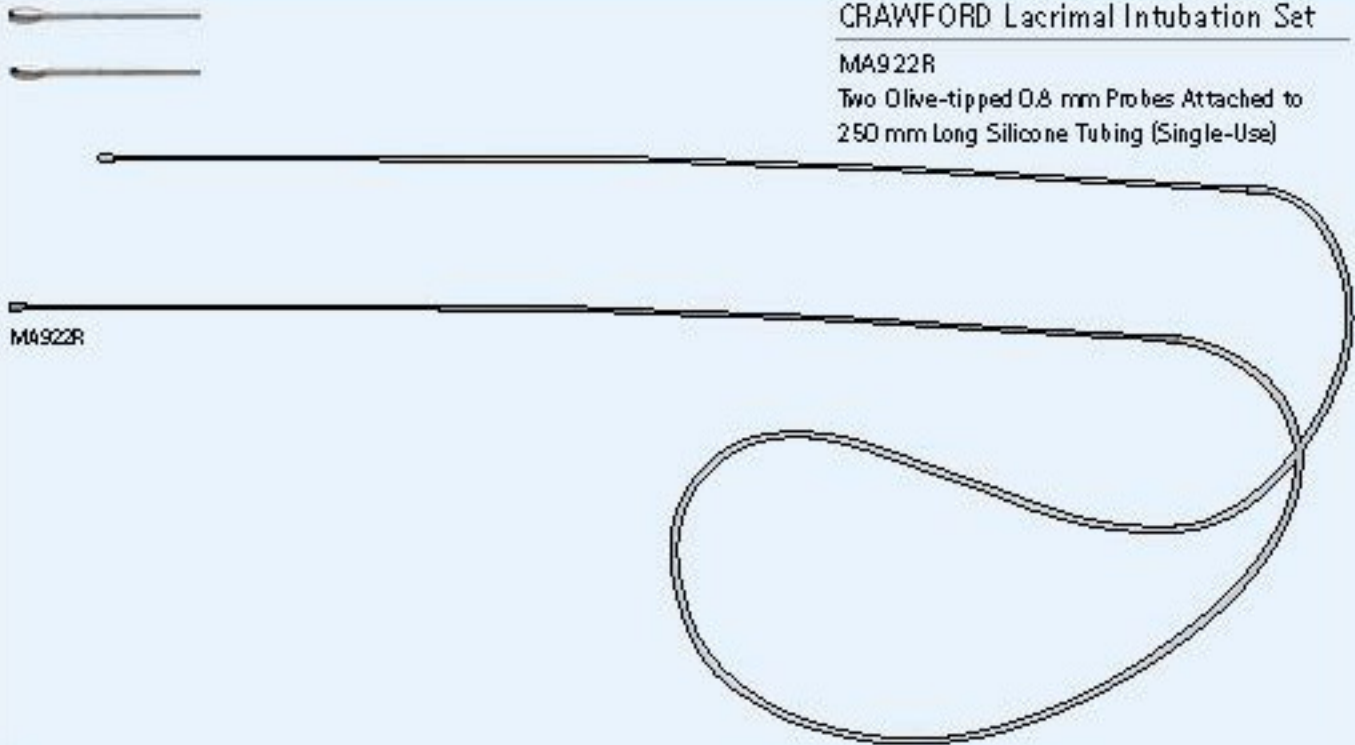

CRAWFORD Retrieving Hook

MA923R

For Use with MA922R, 5 1/8"



Lacrimal Cannulas

MA925R

Straight, Reinforced, Malleable Tip, 23G, 1 3/8"

MA925R



MA926R

Curved, Reinforced, Malleable Tip, 23G, 1 3/8"

MA926R



MA959R

Straight, 23G, 1"

MA959R



SHAHINIAN Lacrimal Cannula

MA927R

Straight, Blunt Tip, 0.3 mm Side Port, 23G, 3/8"

MA927R



RANDOLPH Cyclodialysis Cannula

MA930R

Angled 13 mm from Tip, More Flattened, 19G, 1 3/8"



MA930R



MA970R

MA970R

Angled 13 mm from Tip, Flattened, 19G, 1 1/4"

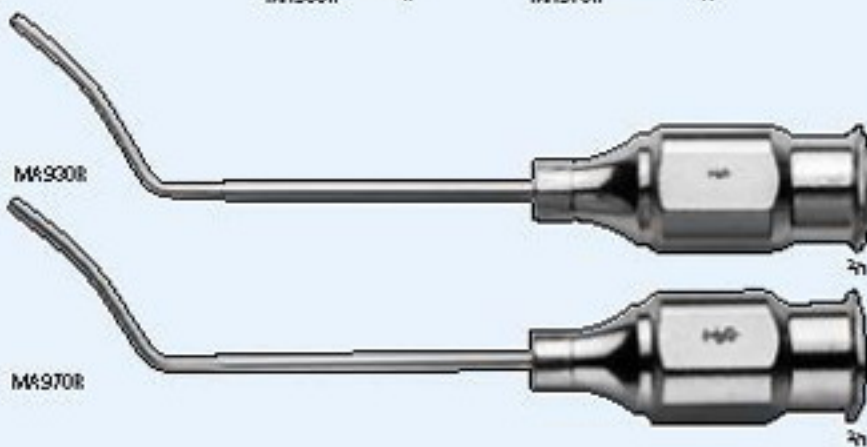

TROUTMAN Olive Tip Cannula

MA931R

Gently Curved, 1 mm Tip, 25G, 1"

MA931R



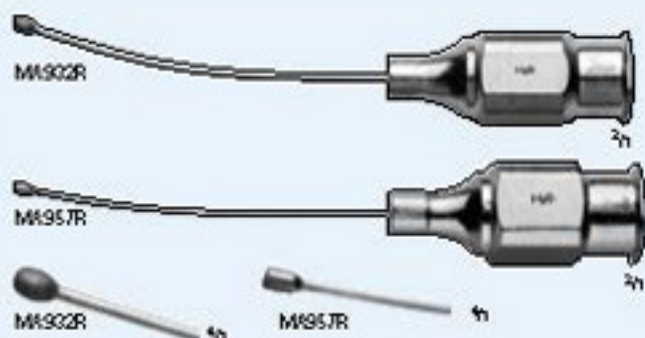

JENSEN Capsule Polisher

MA932R
Curved, Roughened Tip, Front Opening, 25G, 1"

MA957R
Curved, Roughened Tip, Front Opening, 27G, 1"



KNOLLE Capsule Polisher

MA933R
2 mm Angled Tip, Roughened, 30G, 3/4"



BISHOP-HARMON Anterior Chamber Irrigator Set

MA934R
Includes 19G Angled Cannula, Plastic Adaptor, Silicone Bulb

MA935
Silicone Bulb, 28 x 55 mm

MA936
Plastic Adaptor, For Use with MA935

MA937R
Cannula, Angled, 19G, 1"



Hydrodissection Cannula

MA938R
Angled, Flattened Tip, Front Opening, 25G, 3/4"



BRACKEN Irrigating Cannula

MA939R
Curved, Flattened Beveled Tip, Front Opening, 19G, 1 1/4"

SLADE LASIK Cannula

MA940R

Angled, Flattened Spatula Tip, Front Opening,
26G, 1/2"

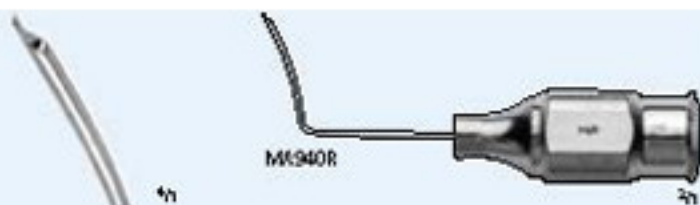

BURATTO Cannula

MA941R

Angled, Slightly Flattened Valvated Tip, 1 Front &
2 Sides Ports, 25G, 1"



MCINTYRE Anterior Chamber Cannulas

MA942R

Angled 12 mm from Tip, Blunt Tip, 23G, 3/4"

MA943R

Angled 12 mm from Tip, Blunt Tip, 26G, 3/4"

MA944R

Angled 12 mm from Tip, Blunt Tip, 30G, 3/4"

MA962R

Straight, Blunt Tip, 23G, 3/4"

MA963R

Straight, Blunt Tip, 26G, 3/4"

MA964R

Straight, Blunt Tip, 30G, 3/4"

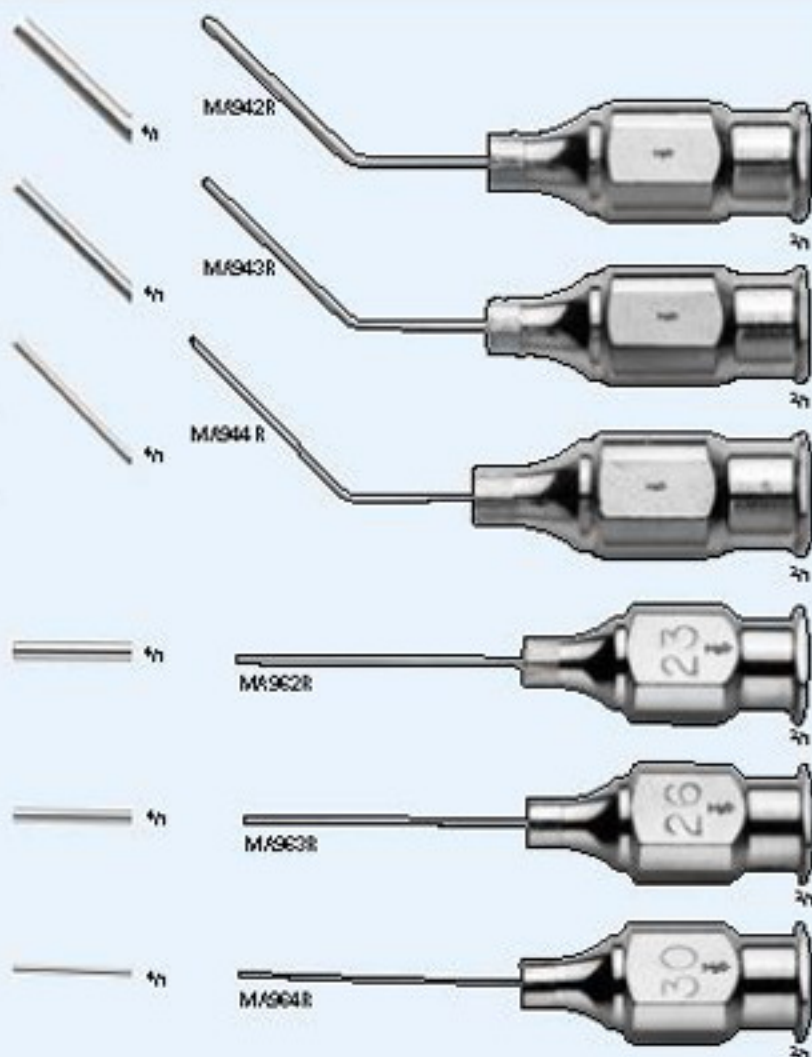

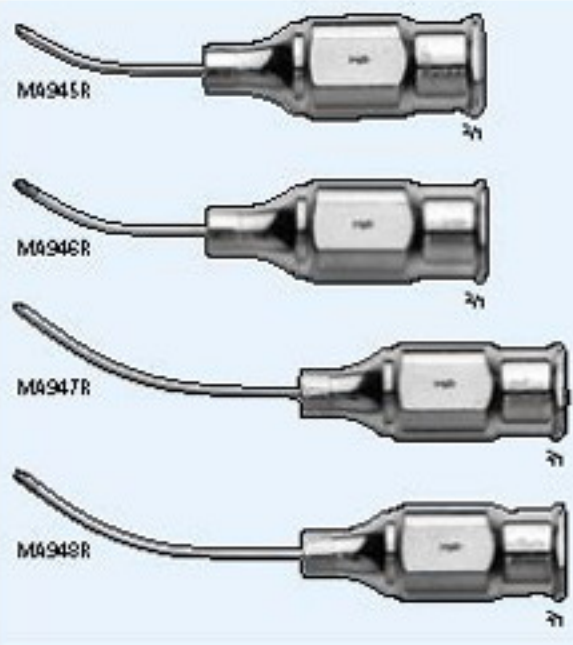

SIMCOE Cortex Extractors

- MA 94 5R
Curved, Smooth Tip, 0.3 mm Side Port, 23G, 1/2"

- MA 94 6R
Curved, Roughened Tip, 0.3 mm Side Port, 23G, 1/2"

- MA 94 7R
Curved, Smooth Tip, 0.3 mm Side Port, 23G, 3/4"

- MA 94 8R
Curved, Roughened Tip, 0.3 mm Side Port, 23G, 3/4"

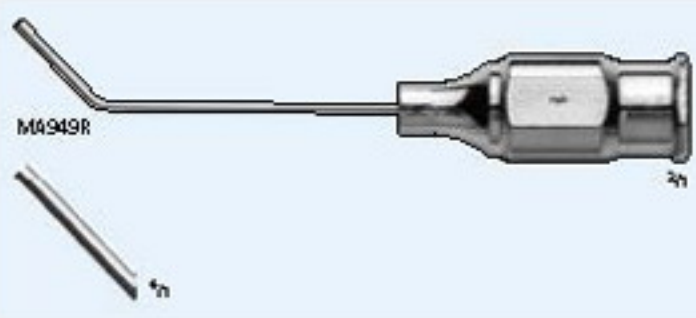

MORRISON Aspirating Cannula

- MA 94 9R
Angled 7 mm from Tip, Smooth Blunt Tip Front Opening, 23G

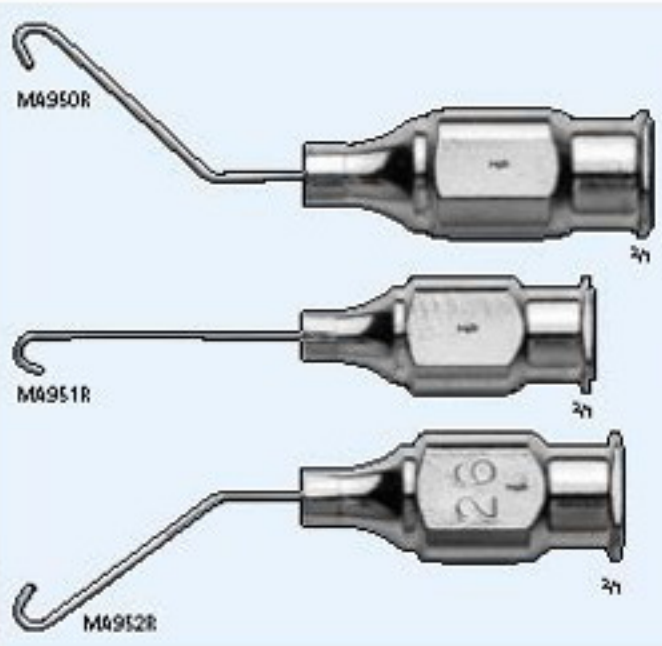

MCINTYRE-BINKHORST Cannulas

- MA 95 0R
Straight, Smooth Blunt Hook-Shaped Tip, Front Opening, 26S, 3/4"

- MA 95 1R
Right Angled, Smooth Blunt Hook-Shaped Tip, Front Opening, 26S, 3/4"

- MA 95 2R
Left Angled, Smooth Blunt Hook-Shaped Tip, Front Opening, 26S, 3/4"

CHANG Nucleus Hydro dissector Cannula

MA953R

Angled 90°, Flat Tip, Beveled Opening, 27G, ½"



ATKINSON Retrobulbar Needle

MA954R

23G, 1¾"



KELMAN Cystotome

MA955R

22G, 1¼"



KRATZ Capsule Scrubber

MA956R

Angled, Roughened, 23G, ¾"



Backflush Infusion Cannula

MA958R

23G, 1¾"



NICHAMIN Hydrodissection Cannula

MA960R

25G



SIMCOE Irrigating Aspirating Unit

MA965R

23G, Aspiration Through 0.3 mm Top Port,
Irrigation Through Front Port, uses 225 mm
Tubing

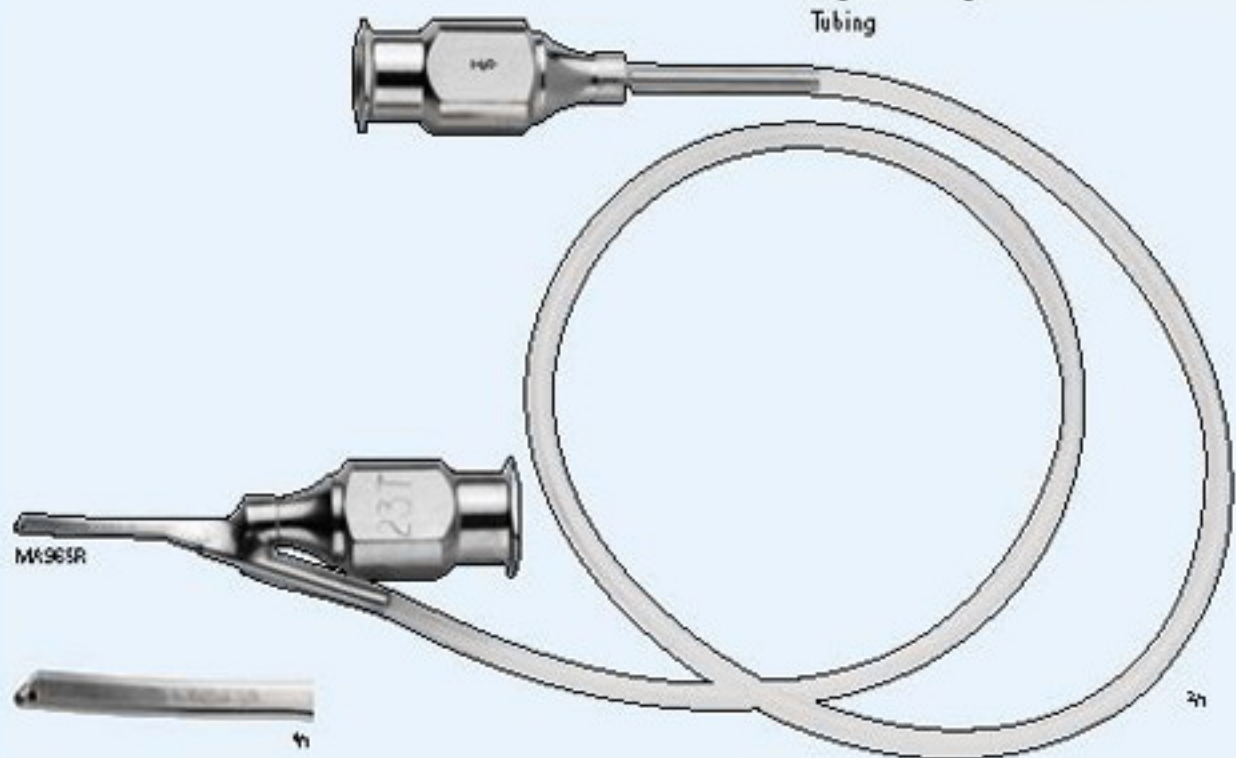

WEST LACRIMAL CANNULA

MA968R

0.3 mm Side Port, 23G, 1 1/4"



Air Injection Cannulas

MA640R

27 Gauge, Angled Tip, 5 mm Tip to Bend, 3/4"

MA641R

30 Gauge, Angled Tip, 5 mm Tip to Bend, 3/4"

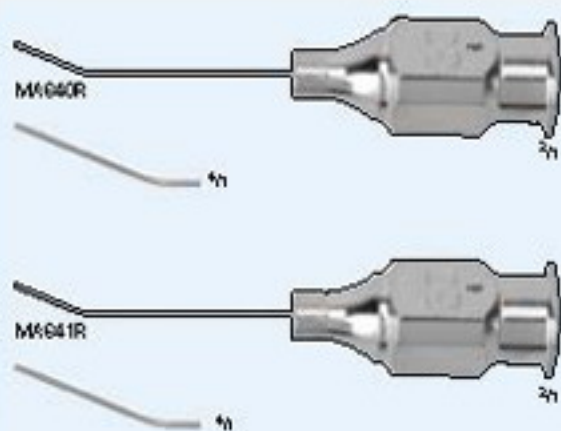

Corneal Dissector Knife

MA767R

Angled Blade, Curved Tip, 4½"

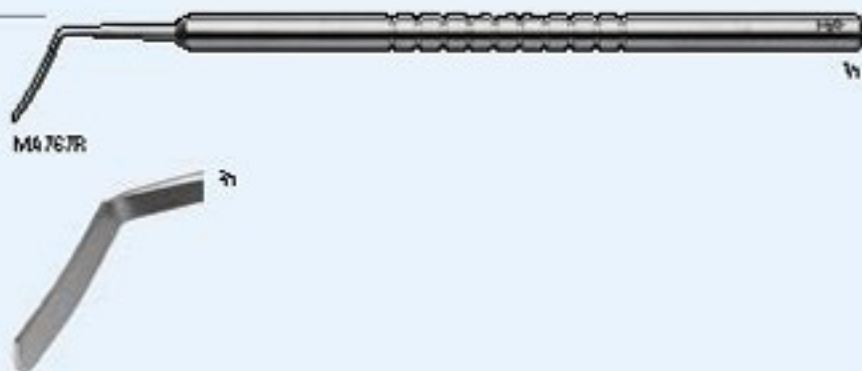

TOOKE Corneal Knife

MA773R

Straight, 3 mm x 18 mm Blade, Curved Cutting Edge, 4¾"



KELLY DESCOMET'S Membrane Punch

MA771R

1 mm Diameter Tip, 5½"



CARTER Sphere Introducer

MA974R

5"

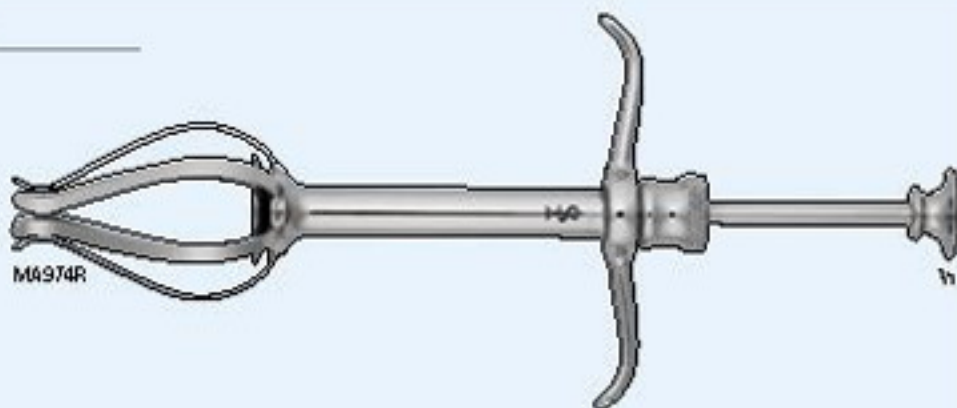

Item No.	Page	Item No.	Page	Item No.	Page	Item No.	Page	Item No.	Page	Item No.	Page
BC004R	31	FD020R	30	MA199R	40	MA477R	35	MA640R	56	MA763R	6
BC005R	31	FD021R	30	MA200R	40	MA478R	35	MA641R	56	MA764R	6
BC008R	32	FD100R	30	MA201R	40	MA479R	35	MA726R	43	MA765R	8
BC009R	32	FD101R	30	MA316R	41	MA480R	35	MA731R	8	MA766R	8
BC010R	32	FD103R	30	MA317R	41	MA483R	29	MA732R	23	MA767R	57
BC011R	32	FD230R	45	MA351R	45	MA484R	29	MA733R	23	MA771R	57
BC020R	33	FD231R	45	MA352R	45	MA485R	29	MA734R	23	MA773R	57
BC021R	33	FD232R	45	MA353R	45	MA486R	29	MA735R	23	MA775R	20
BC050R	31	FD233R	45	MA354R	45	MA487R	30	MA736R	23	MA776R	14
BC164R	33	FD242R	46	MA355R	46	MA548R	41	MA737R	23	MA777R	10
BC165R	33	FD243R	46	MA356R	46	MA612R	29	MA738R	23	MA778R	10
BC170R	32	MA001R	4	MA357R	45	MA613R	30	MA739R	23	MA779R	10
BC171R	32	MA002R	4	MA358R	45	MA614R	30	MA740R	23	MA780R	11
BC172R	32	MA005R	4	MA360R	45	MA617R	41	MA741R	23	MA781R	11
BC173R	32	MA148R	38	MA362R	47	MA618R	38	MA742R	23	MA782R	11
BC186R	32	MA149R	38	MA363R	46	MA619R	41	MA743R	23	MA783R	11
BC187R	32	MA150R	38	MA364R	46	MA620R	41	MA744R	9	MA784R	11
BC194R	32	MA151R	38	MA366R	46	MA621R	42	MA745R	9	MA785R	12
BC195R	32	MA152R	38	MA367R	46	MA622R	42	MA747R	9	MA786R	12
BC210R	33	MA153R	38	MA368R	46	MA623R	43	MA749R	8	MA789R	12
BC211R	33	MA154R	38	MA407R	48	MA624R	42	MA750R	6	MA790R	12
BC211W	33	MA155R	39	MA410R	48	MA625R	42	MA751R	5	MA791R	13
BC256R	33	MA157R	39	MA411R	48	MA626R	43	MA752R	5	MA792R	13
BC257R	33	MA158R	38	MA412R	48	MA628R	46	MA754R	5	MA793R	13
BC257W	33	MA166R	39	MA413R	48	MA630R	17	MA755R	5	MA794R	13
BC628R	34	MA167R	39	MA414R	48	MA631R	19	MA756R	5	MA795R	13
BD330R	40	MA170R	40	MA434R	8	MA632R	21	MA757R	5	MA796R	14
BD331R	40	MA171R	40	MA435R	8	MA633R	21	MA758R	6	MA797R	14
BD333R	40	MA195R	40	MA436R	8	MA634R	21	MA759R	6	MA798R	15
BD335R	40	MA196R	40	MA437R	8	MA635R	21	MA760R	6	MA799R	15
BM560R	45	MA197R	40	MA475R	34	MA636R	21	MA761R	9	MA800R	22
BM562R	45	MA198R	40	MA476R	35	MA637R	15	MA762R	6	MA801R	16



Roras Road, New Adalat Grah
Sialkot-51310 Pakistan

Cell: +92-321 6115424

Email: info@mersamedical.com

Email: shahzad@mersamedical.com

Web: www.mersamedical.com



REUSABLE WITH THE BLADES

being replaceable

BP HANDLE



DOUBLE

spring instruments

HOLDER STRAIGHT

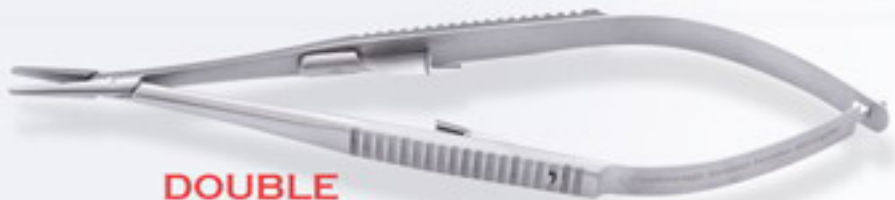

**OPHTHALMIC
INSTRUMENTS**