



Mersa Medical
INSTRUMENTS
Manufacturer & Exporter of Quality Instruments

Manufacturer & Exporter of
Surgical
Instruments



CONTENTS

GENERAL INSTRUMENTS

Page



SCALPEL HANDLES _____	5
SCISSORS _____	5
NEEDLE HOLDERS _____	5
DISSECTING FORCEPS _____	6
ARTERY FORCEPS _____	6
SUTURE CARRIERS _____	7
TROCARS _____	7
SUCTION TUBES _____	7

AURAL (EAR) INSTRUMENTS



HOOKS _____	8
MYRINGOTOMES _____	8
PROBES _____	8
SPECULA _____	8
CROCODILE FORCEPS _____	9
PICKS _____	9

NASAL INSTRUMENTS



PUNCHES _____	10
DRESSING FORCEPS _____	10
ELEVATORS _____	10
CARTILAGE KNIVES _____	11
SNARES _____	11
SPECULA _____	12,13
TURBINATE FORCEPS _____	13

ORAL (MOUTH) INSTRUMENTS



MOUTH GAGS _____	14
BIPODS & PLATES _____	15
TONSIL DISSECTORS _____	15
TONSIL HOLDING FORCEPS _____	15
ADENOID CURETTES _____	16
TONSIL SNARES _____	16
GOUGES _____	17
MALLETS _____	17
SYRINGES _____	17
DIATHERMY NEEDLES & CABLES _____	18
BIPOLAR FORCEPS & CABLES _____	18

28.715.40	Thudicum Nasal Speculum Set of 5	12
28.685.10	Killian Nasal Speculum 2" (5cm) x 5.5" (13cm) Self Retaining	12
28.685.20	Killian Nasal Speculum 2.5" (6.5cm) x 5.5" (13cm) Self Retaining	12
28.685.30	Killian Nasal Speculum 3" (7.5cm) x 5.5" (13cm) Self Retaining	12
28.685.40	Killian Nasal Speculum 3.5" (9cm) x 5.5" (13cm) Self Retaining	12
28.750.20	Thudicum Nasal Speculum No:2 Diathermy Insulated	13
11.550.10	Scalpel Handle No:3 Stainless Steel	5
28.470.80	Freer Elevator Sharp & Dull Blade 7.5" (19cm) Double Ended (8)	10
28.400.10	Hill Elevator/Dissector Double Ended 9" (23cm)	10
28.450.10	Ballenger Nasal Knife Straight 6mm Blade 8" (20cm)	11
28.310.10	Tilley Henckel Punch 4.5mm Jaw x 4.5" (11.5cm) Shaft	10
28.310.20	Tilley Henckel Punch 5.5mm Jaw x 4.5" (11.5cm) Shaft	10
40.798.10	Small Mallet Stainless Steel 8.5oz Smooth Head	17
40.530.20	Jenkin Gouge Straight 6mm x 5.5" (14cm)	17
40.530.25	Jenkin Gouge Straight 8mm x 5.5" (14cm)	17
28.805.10	Luc Turbinate Forceps Oval Small 6mm x 7.5" (19cm)	13
28.805.20	Luc Turbinate Forceps Oval Medium 7.5mm x 7.5" (19cm)	13
28.805.30	Luc Turbinate Forceps Oval Large 9mm x 7.5" (19cm)	13
28.380.10	Tilley Nasal Dressing Forceps 7" (18cm)	10
21.870.10	Zoellner Suction Tube	7
21.870.35	Zoellner Suction Tube End 20swg	7
21.780.30	Self Clearing Suction Tube Medium	7
12.415.25	Heymann Turbinectomy Scissors Angled 7" (18cm)	5
12.985.20	Strabismus Scissors Curved 4.5" (11.5cm) Blunt/Blunt Tungsten Carbide	5
17.330.10	Crilewood Needle Holder 6" (15.5cm) Tungsten Carbide	5
14.325.20	Halstead Mosquito Artery Forceps Straight 5" (13cm) Standard	6
745.550.40	Dental Cartridge (A) Syringe Self Aspirating 2.2ml	17
86.800.40	Abbey Sub-Mucosal Needle Diathermy Insulated	18
86.251.20	Diathermy Cable 3 Meter Pin Fitting 4mm End	18
21.200.25	Tilley Litchwitz Trocar Complete 7.5fg	7
21.200.65	Tilley Litchwitz Cannula Only 7.5fg	7
28.620.10	Glegg Nasal Snare Self Forming 9" (23cm)	11
28.635.10	Negus Nasal Snare 9" (23cm)	11
13.225.10	Gillies Dissecting Forceps 6" (15.5cm) 1x2 Teeth Serrated	6
13.295.10	Mcindoe Dissecting Forceps 6" (15.5cm) Serrated	6

SCALPEL HANDLES

29

27



26

11.550.10 SCALPEL HANDLE NO.3 STAINLESS STEEL

25

11.550.30 SCALPEL HANDLE NO.4 STAINLESS STEEL (NOT ILLUSTRATED)

SCISSORS

Although we produce other Turbinectomy scissors, such as Beckman and Cottle, the Heyman is the most popular for Turbinectomy procedures.

Our full range of T-Carb Tungsten Carbide instruments are available in our full colour 24 page Tungsten Carbide Catalogue.

23



12.415.25 HEYMANN TURBINECTOMY SCISSORS ANGLED 7" (18CM)

22

21

20

19

18



12.965.20 MCINDOE SCISSORS CURVED 7" (18CM) BLUNT/BLUNT T.C.

16

15

14

13



12.985.20 STRABISMUS SCISSORS CURVED 4.5" (11.5CM) BLUNT/BLUNT T.C.

12

12.985.10 STRABISMUS SCISSORS STRAIGHT 4.5" (11.5CM) BLUNT/BLUNT T.C. (NOT ILLUSTRATED)

11

10

NEEDLEHOLDERS

8

7

6

5

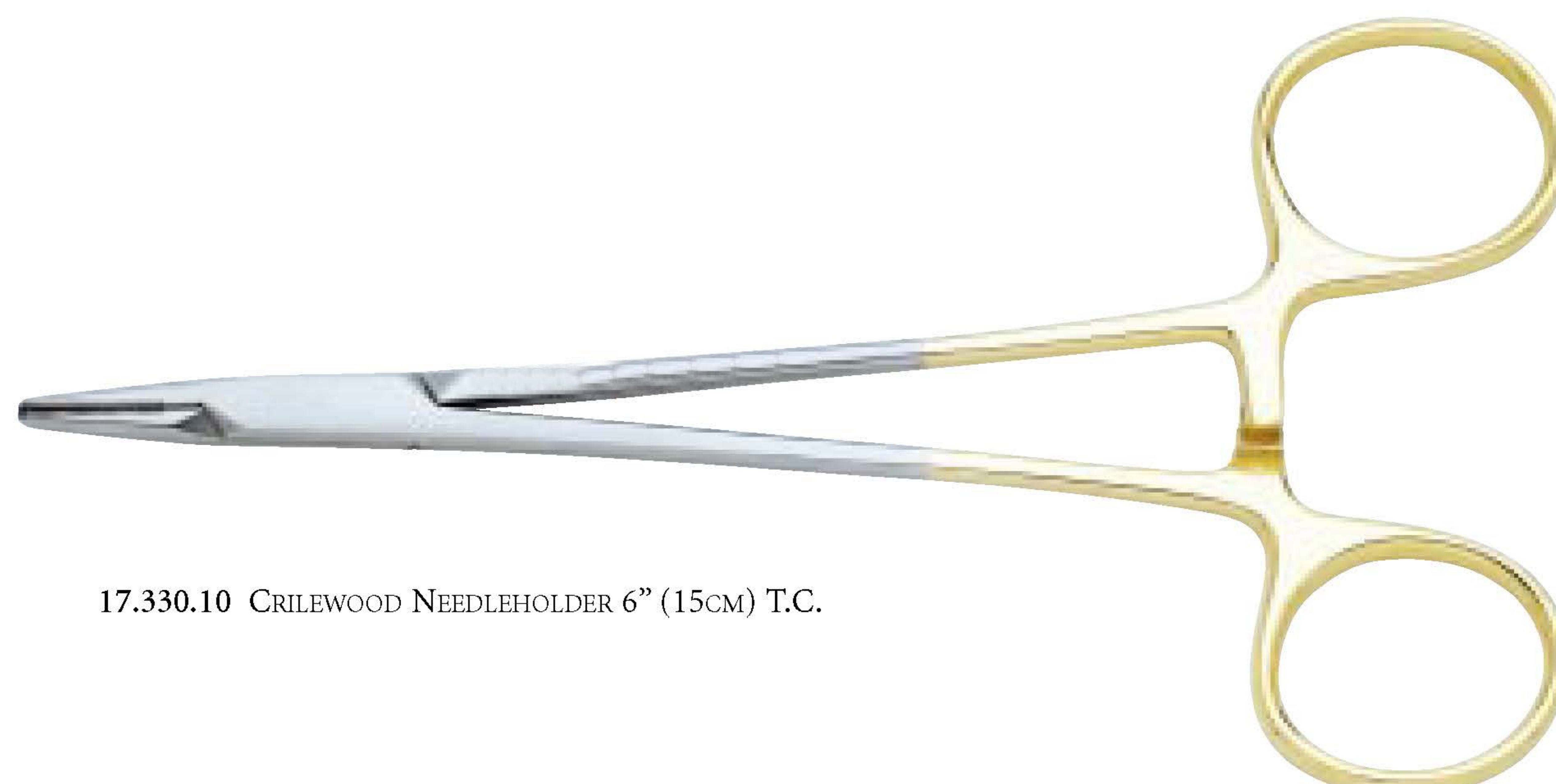

17.330.10 CRILEWOOD NEEDLEHOLDER 6" (15CM) T.C.

4

3

2

5

SUTURE CARRIERS

Our Negus Knot Tier has a fine tip with smooth edges to avoid sutures snagging or cutting.



17.960.10 NEGUS KNOT TIER AND PUSHER 8" (20CM)

TROCARS

Traditionally used for antral wash outs. Other sizes are also available.



21.200.25 TILLEY LITCHWITZ TROCAR COMPLETE 7.5FG

21.200.20 TILLEY LITCHWITZ TROCAR COMPLETE 7FG (NOT ILLUSTRATED)

SUCTION TUBES

Self Clearing Suction Tube - This model has a built in stillette which allows the tube to be cleared of any blockages whilst in use.

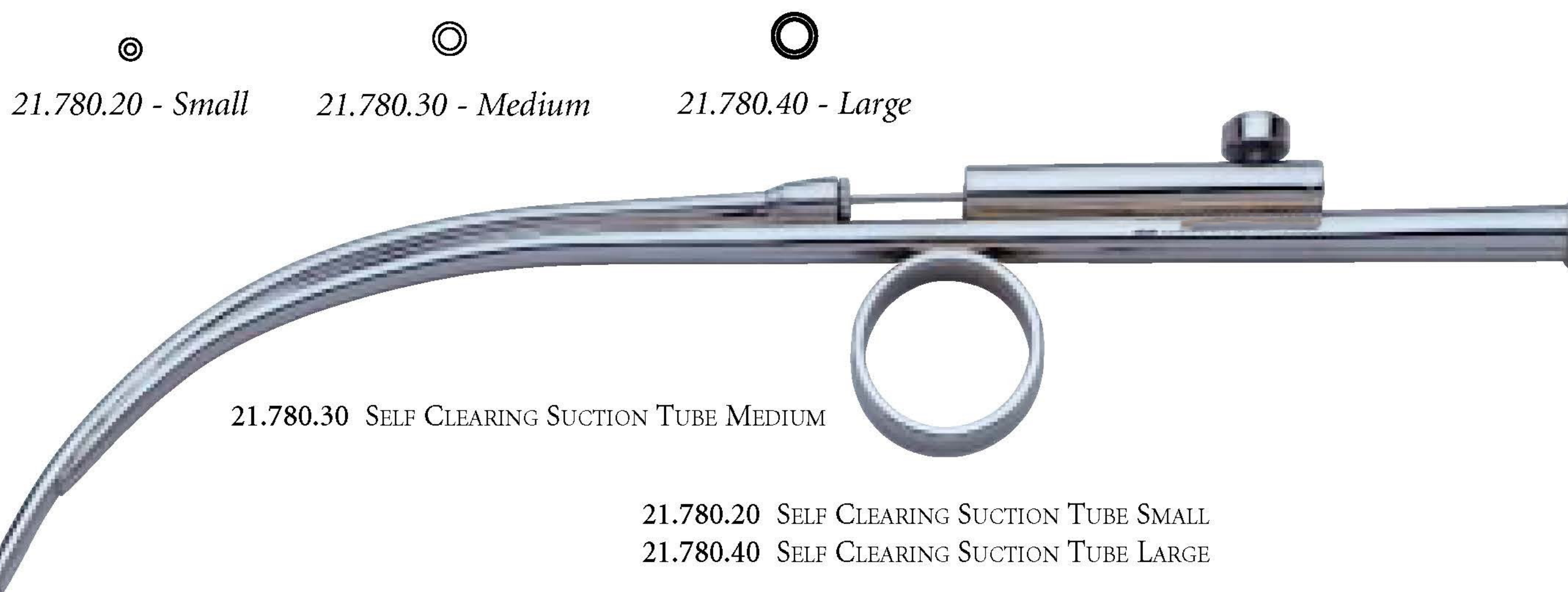

21.780.20 - Small

21.780.30 - Medium

21.780.40 - Large

21.780.30 SELF CLEARING SUCTION TUBE MEDIUM

21.780.20 SELF CLEARING SUCTION TUBE SMALL

21.780.40 SELF CLEARING SUCTION TUBE LARGE

The Yankauer Suction Tube has a rose end which may be removed for cleaning. Ideal for suction in tonsil and adenoid procedures.

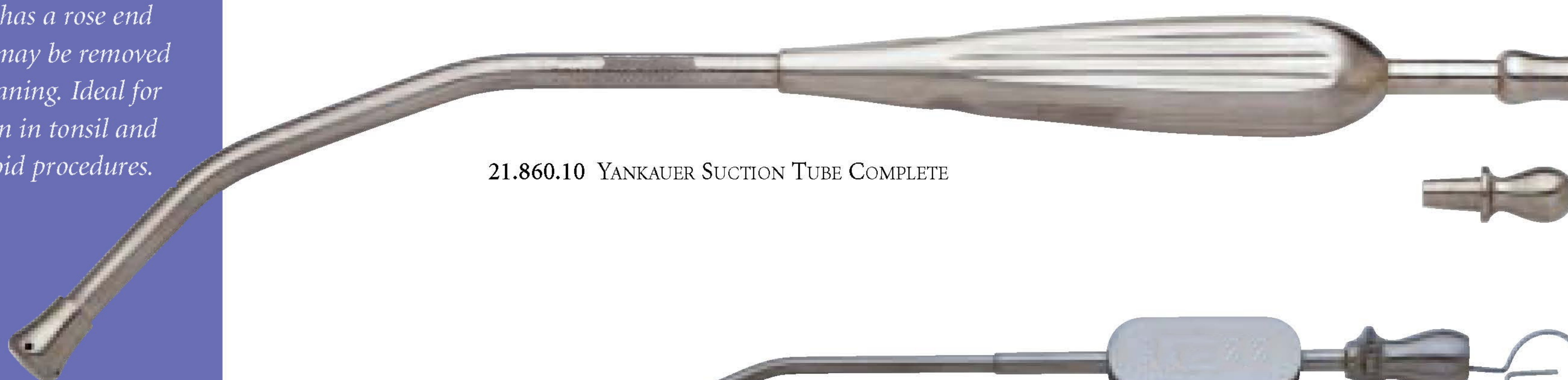

21.860.10 YANKAUER SUCTION TUBE COMPLETE

The Zoellner Suction Tube is ideal for small, localised suction due to its narrow size. The various detachable suction tube ends allow pin point suction if required.

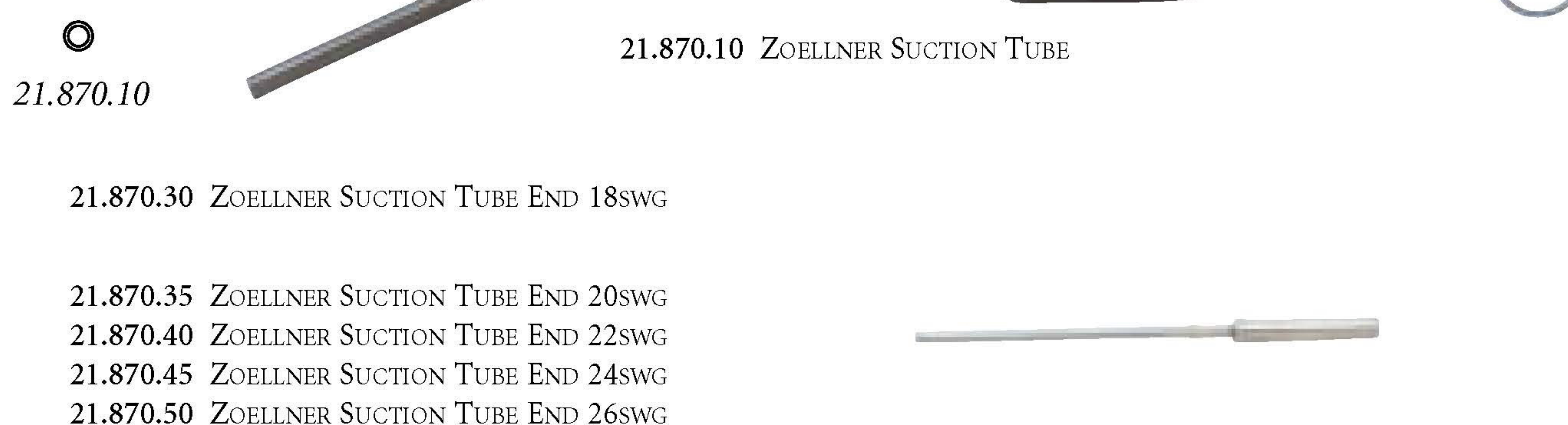

21.870.10

21.870.10 ZOELLNER SUCTION TUBE

21.870.30 ZOELLNER SUCTION TUBE END 18SWG

21.870.35 ZOELLNER SUCTION TUBE END 20SWG

21.870.40 ZOELLNER SUCTION TUBE END 22SWG

21.870.45 ZOELLNER SUCTION TUBE END 24SWG

21.870.50 ZOELLNER SUCTION TUBE END 26SWG

MYRINGOTOMES, HOOKS AND PROBES

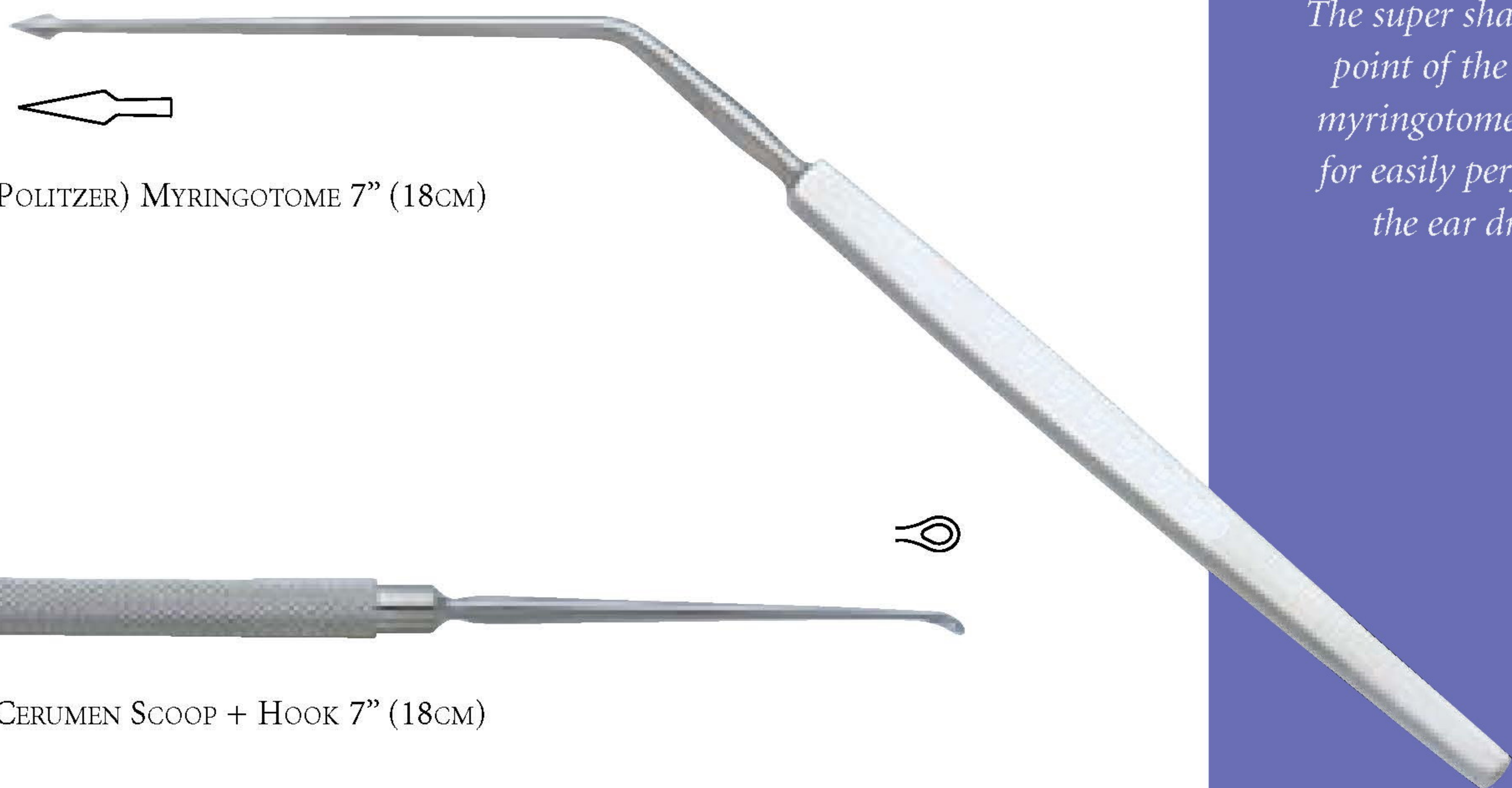

26.560.10 AGNEW (POLITZER) MYRINGOTOME 7" (18CM)

The super sharp trocar point of the Agnew myringotome is ideal for easily perforating the ear drum.



26.130.10 FORMBY CERUMEN SCOOP + HOOK 7" (18CM)



26.675.20 JOBSON HORNE PROBE DOUBLE ENDED 7" (18CM)

SPECULA



26.813.10 GRUBER SPECULUM SET OF 4 OVAL BLACK

- 26.813.13 GRUBER SPECULUM 2MM OVAL BLACK
- 26.813.15 GRUBER SPECULUM 3MM OVAL BLACK
- 26.813.20 GRUBER SPECULUM 4MM OVAL BLACK
- 26.813.25 GRUBER SPECULUM 5MM OVAL BLACK
- 26.813.30 GRUBER SPECULUM 7MM OVAL BLACK

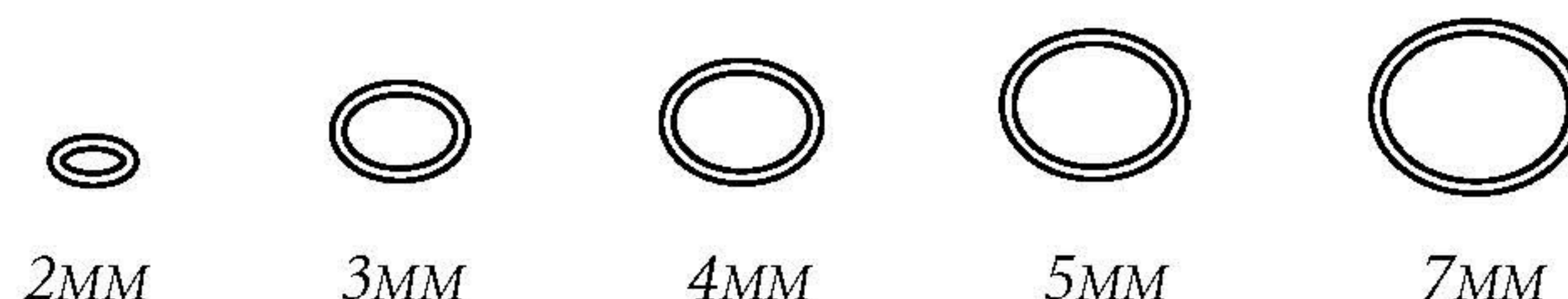

26.889.10 TUMARKIN SPECULUM SET OF 8, 0-7 ROUND BLACK SLOT

- 26.889.15 TUMARKIN SPECULUM No.0 ROUND BLACK SLOT
- 26.889.20 TUMARKIN SPECULUM No.1 ROUND BLACK SLOT
- 26.889.25 TUMARKIN SPECULUM No.2 ROUND BLACK SLOT
- 26.889.30 TUMARKIN SPECULUM No.3 ROUND BLACK SLOT
- 26.889.35 TUMARKIN SPECULUM No.4 ROUND BLACK SLOT
- 26.889.40 TUMARKIN SPECULUM No.5 ROUND BLACK SLOT
- 26.889.45 TUMARKIN SPECULUM No.6 ROUND BLACK SLOT
- 26.889.50 TUMARKIN SPECULUM No.7 ROUND BLACK SLOT

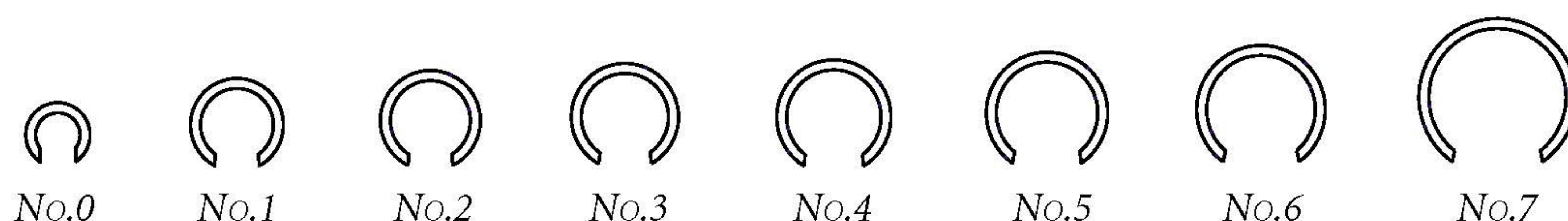

The Gruber and Tumarkin are our most popular ear specula. We have shown here the blackened variety, which are specially coated to prevent reflection or glare experienced when using the non coated steel versions.

FORCEPS AND PICKS



We manufacture a large range of crocodile forceps for middle ear procedures. Various models are available for grasping, cutting, biopsies and grommet insertions. A small selection of the blackened versions are shown here, which reduce glare or reflection under bright illumination. We also supply these in uncoated steel versions.



29

27

26

25

24

23

22

21

20

19

18

17

16

15

14

13

12

11

10

9

8

7

6

5

4

3

2

9

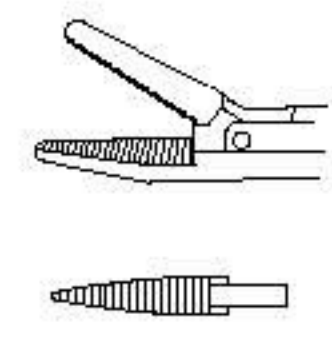

27.240.40 HARTMAN CROCODILE MICRO SERRATED BLACK

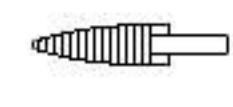

27.245.40 HARTMAN CROCODILE SUPER FINE SERRATED BLACK



27.246.40 HARTMAN CROCODILE EXTRA SUPER FINE SERRATED BLACK

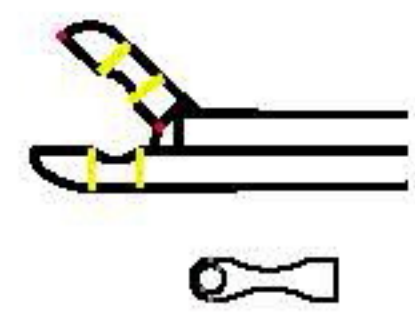

27.320.30 ORMEROD CROCODILE MICRO CUP BLACK

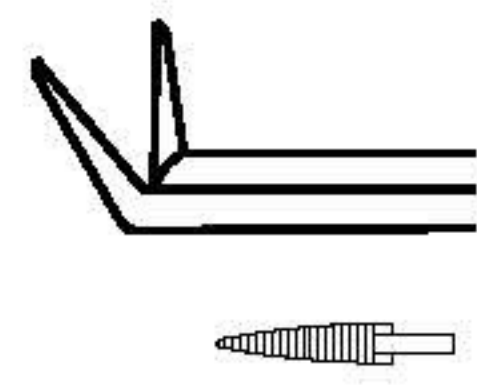

27.320.20 ORMEROD CROCODILE MICRO SERRATED UP BLACK



27.320.40 ORMEROD CROCODILE MICRO ELONGATED CUP BLACK

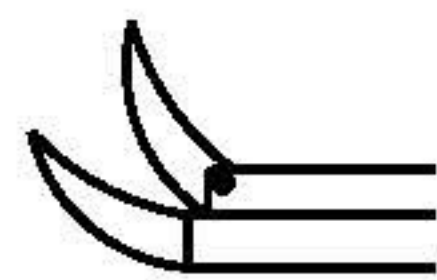

27.320.50 ORMEROD CROCODILE MICRO SCISSORS BLACK



27.685.50 SCHUKNECHT PICK STRAIGHT 178MM BLACK

PUNCHES AND DRESSING FORCEPS

28.380.10 TILLEY NASAL DRESSING FORCEPS 7" (18CM)

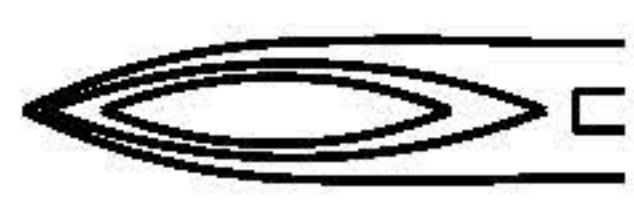

28.310.10 TILLEY HENCKEL PUNCH 4.5MM JAW X 11.5CM (4.5") SHAFT

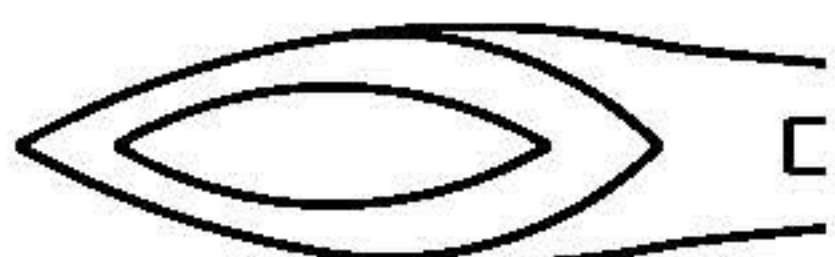

28.310.20 TILLEY HENCKEL PUNCH 5.5MM JAW X 11.5CM (4.5") SHAFT

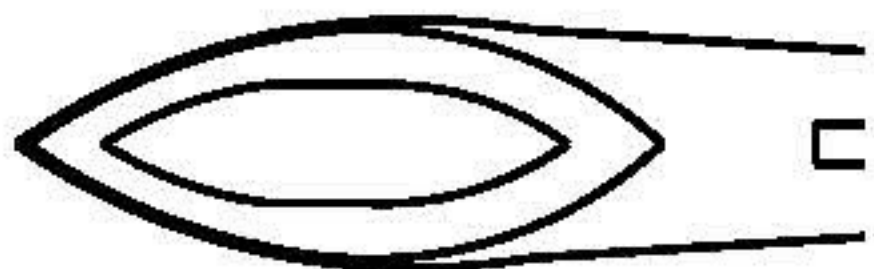

28.310.30 TILLEY HENCKEL PUNCH 6.5MM JAW X 11.5CM (4.5") SHAFT

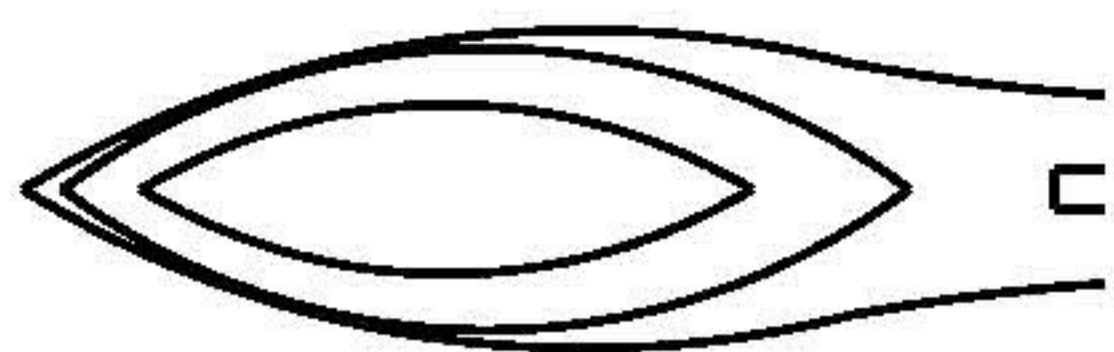

28.310.40 TILLEY HENCKEL PUNCH 8MM JAW X 11.5CM (4.5") SHAFT

Tilley Henckel - Ideal for nasal turbinectomy procedures. The powerful shanks and specially hardened jaws provide a strong, clean bite.

ELEVATORS

28.400.10 HILL ELEVATOR/ DISSECTOR DOUBLE ENDED 9" (23CM)



28.470.80 FREER ELEVATOR SHARP + BLUNT BLADE 7.5" (19CM) DOUBLE ENDED



We manufacture a full range of Freer elevators, this double ended model is the most popular model with a sharp and a blunt blade.

CARTILAGE KNIVES

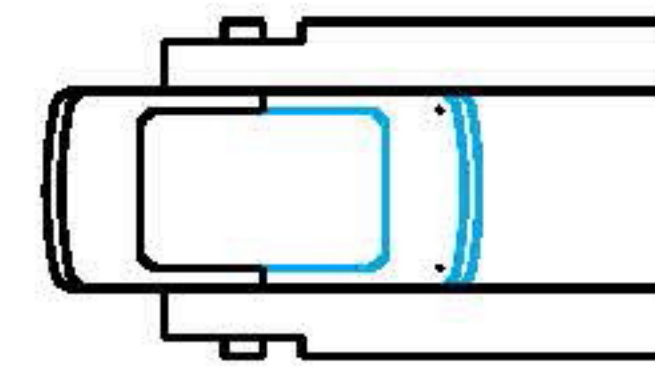

28.450.10 BALLENGER NASAL KNIFE STRAIGHT 8" (20CM) 6MM BLADE

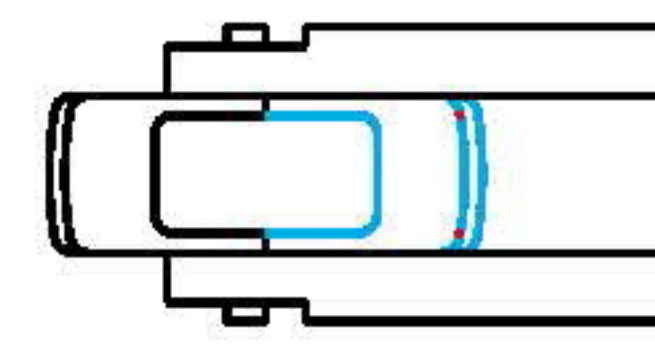

28.450.05 BALLENGER NASAL KNIFE STRAIGHT 8" (20CM) 4MM BLADE

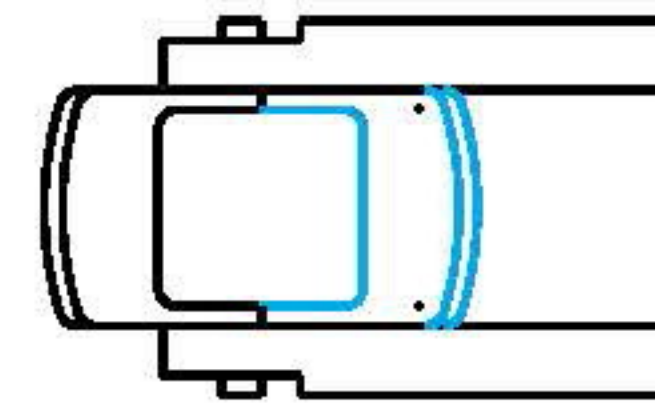

28.450.20 BALLENGER NASAL KNIFE STRAIGHT 8" (20CM) 8MM BLADE

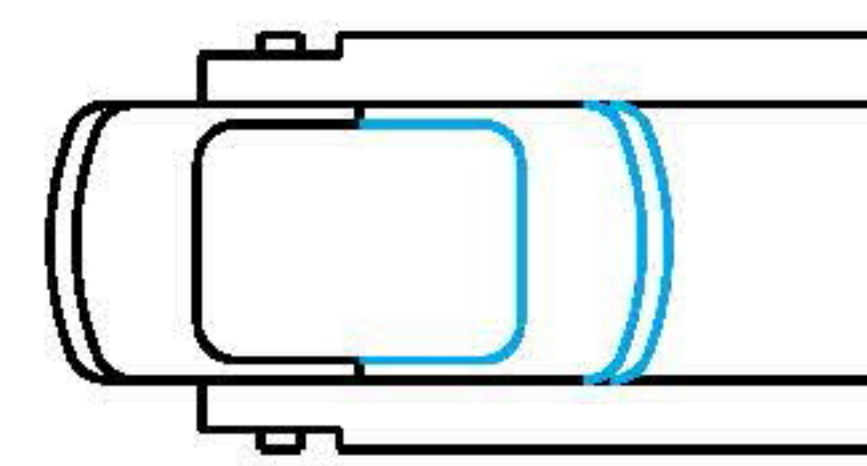

28.450.30 BALLENGER NASAL KNIFE ANGLED 8" (20CM) 6MM BLADE

Ballenger Knives have super sharp blades to allow easy and controlled cutting of the nasal cartilage. The angled version (28.450.30) has a crank bend in the shank for use where access may be restricted.

NASAL SNARES



The Glegg Nasal Snare has a mechanism in the tip which pushes the wire apart as it is

extended from the tip, thus automatically forming a loop. The Negus requires the loop to be formed manually by hand before use. Both snares can be disassembled for replacement of the wire and cleaning.



28.620.10 GLEGG NASAL SNARE SELF FORMING 9" (23CM)



28.635.10 NEGUS NASAL SNARE 9" (23CM)



28.685.10 KILLIAN NASAL SPECULUM 2" (5CM) x 5.5" (13CM) SELF RETAINING

28.685.20 KILLIAN NASAL SPECULUM 2.5" (6.5CM) x 5.5" (13CM) SELF RETAINING

28.685.30 KILLIAN NASAL SPECULUM 3" (7.5CM) x 5.5" (13CM) SELF RETAINING

28.685.40 KILLIAN NASAL SPECULUM 3.5" (9CM) x 5.5" (13CM) SELF RETAINING

The Killian is a very popular deep nasal speculum due to the various lengths available and its self retaining mechanism. Its simple thumb screw, allows it to stay open, unaided whilst in use.

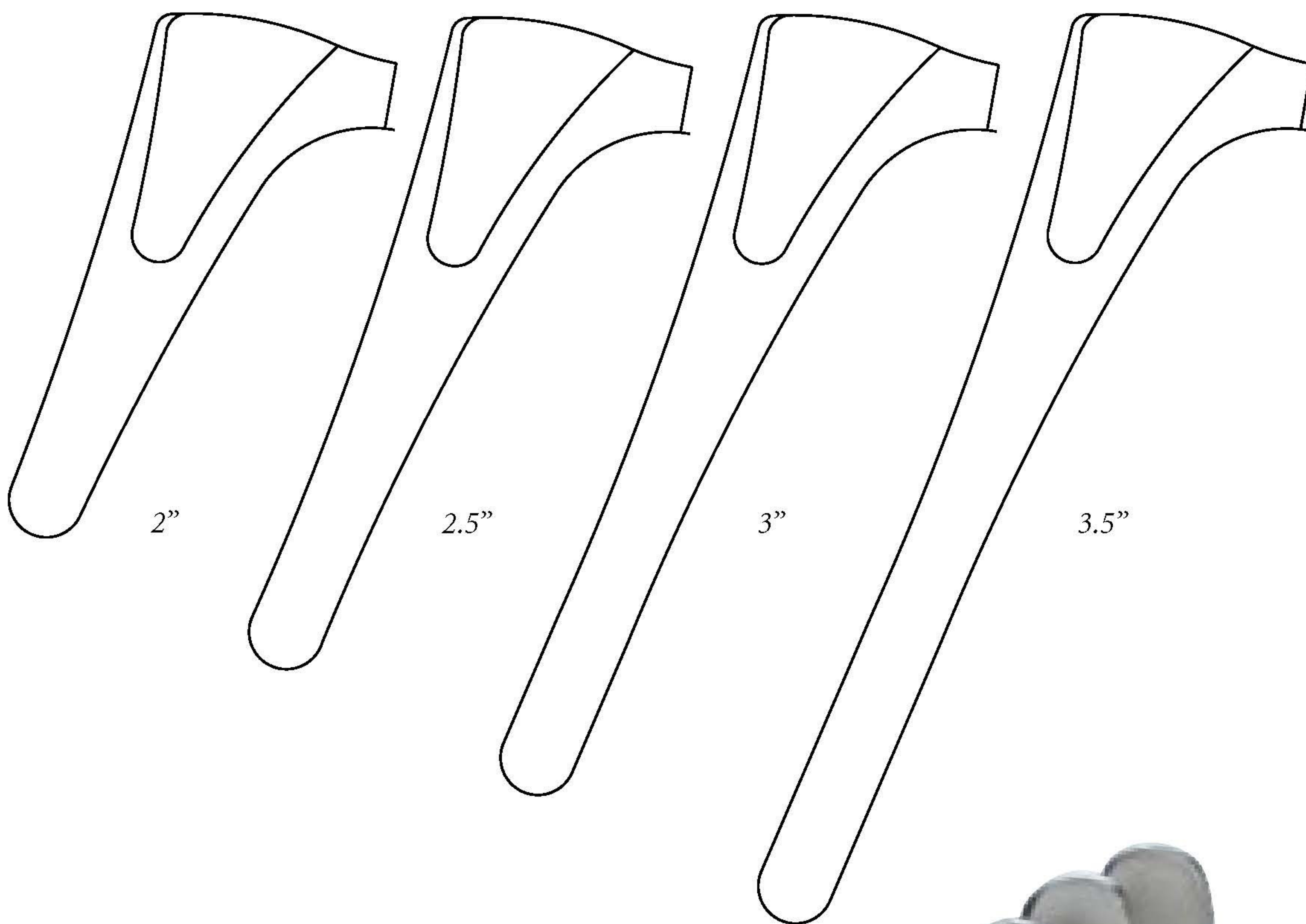

28.715.40 THUDICUM NASAL SPECULUM SET OF 5

- 28.715.10 THUDICUM NASAL SPECULUM No.0
- 28.715.15 THUDICUM NASAL SPECULUM No.1
- 28.715.20 THUDICUM NASAL SPECULUM No.2
- 28.715.25 THUDICUM NASAL SPECULUM No.3
- 28.715.30 THUDICUM NASAL SPECULUM No.4

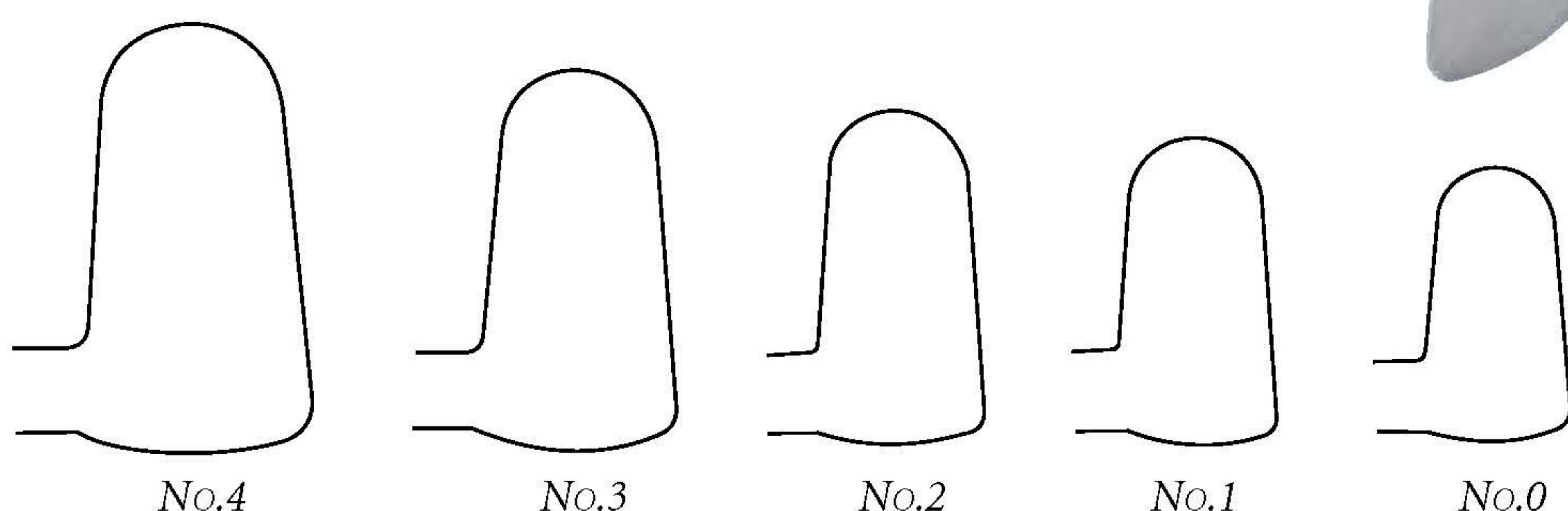

THUDICUM SIZES

NASAL SPECULAE

Our insulated diathermy Thudicums may be used with electrosurgery procedures. The insulated coating is fully autoclaveable.

The Mark Hovell variety are similar in design to the Thudicums but with a slightly different head shape and size. These are also available in insulated diathermy versions.



28.750.20 THUDICUM NASAL SPECULUM No.2 INSULATED

28.750.10 THUDICUM NASAL SPECULUM No.0 INSULATED

28.750.15 THUDICUM NASAL SPECULUM No.1 INSULATED

28.750.25 THUDICUM NASAL SPECULUM No.3 INSULATED

28.750.30 THUDICUM NASAL SPECULUM No.4 INSULATED

28.750.50 THUDICUM NASAL SPECULUM SET OF 5 INSULATED

28.690.10 MARK HOVELL NASAL SPECULUM No:1

28.690.15 MARK HOVELL NASAL SPECULUM No:2

28.690.20 MARK HOVELL NASAL SPECULUM No:3

28.690.25 MARK HOVELL NASAL SPECULUM No:4

28.690.30 MARK HOVELL NASAL SPECULUM No:5

28.690.35 MARK HOVELL NASAL SPECULUM No:6

28.690.40 MARK HOVELL NASAL SPECULUM No:7

28.690.50 MARK HOVELL NASAL SPECULUM SET OF 7

28.740.10 MARK HOVELL NASAL SPECULUM No.1 INSULATED

28.740.15 MARK HOVELL NASAL SPECULUM No.2 INSULATED

28.740.20 MARK HOVELL NASAL SPECULUM No.3 INSULATED

28.740.25 MARK HOVELL NASAL SPECULUM No.4 INSULATED

28.740.30 MARK HOVELL NASAL SPECULUM No.5 INSULATED

28.740.35 MARK HOVELL NASAL SPECULUM No.6 INSULATED

28.740.40 MARK HOVELL NASAL SPECULUM No.7 INSULATED

28.740.60 MARK HOVELL NASAL SPECULUM SET OF 7 INSULATED

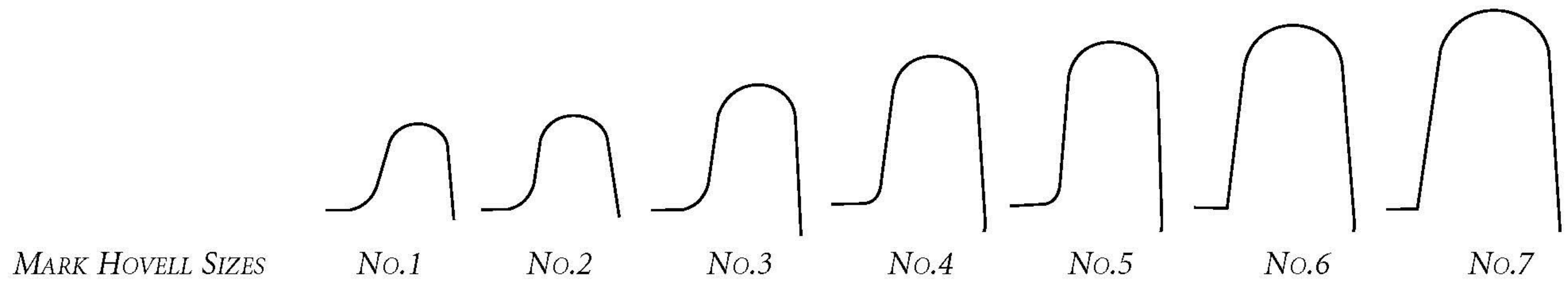

MARK HOVELL SIZES

No.1

No.2

No.3

No.4

No.5

No.6

No.7

TURBINATE FORCEPS

Luc Turbinate - A very popular instrument for nasal turbinectomy procedures, the long jaws allow deep access and the super sharp jaws provide a clean and easy cut.

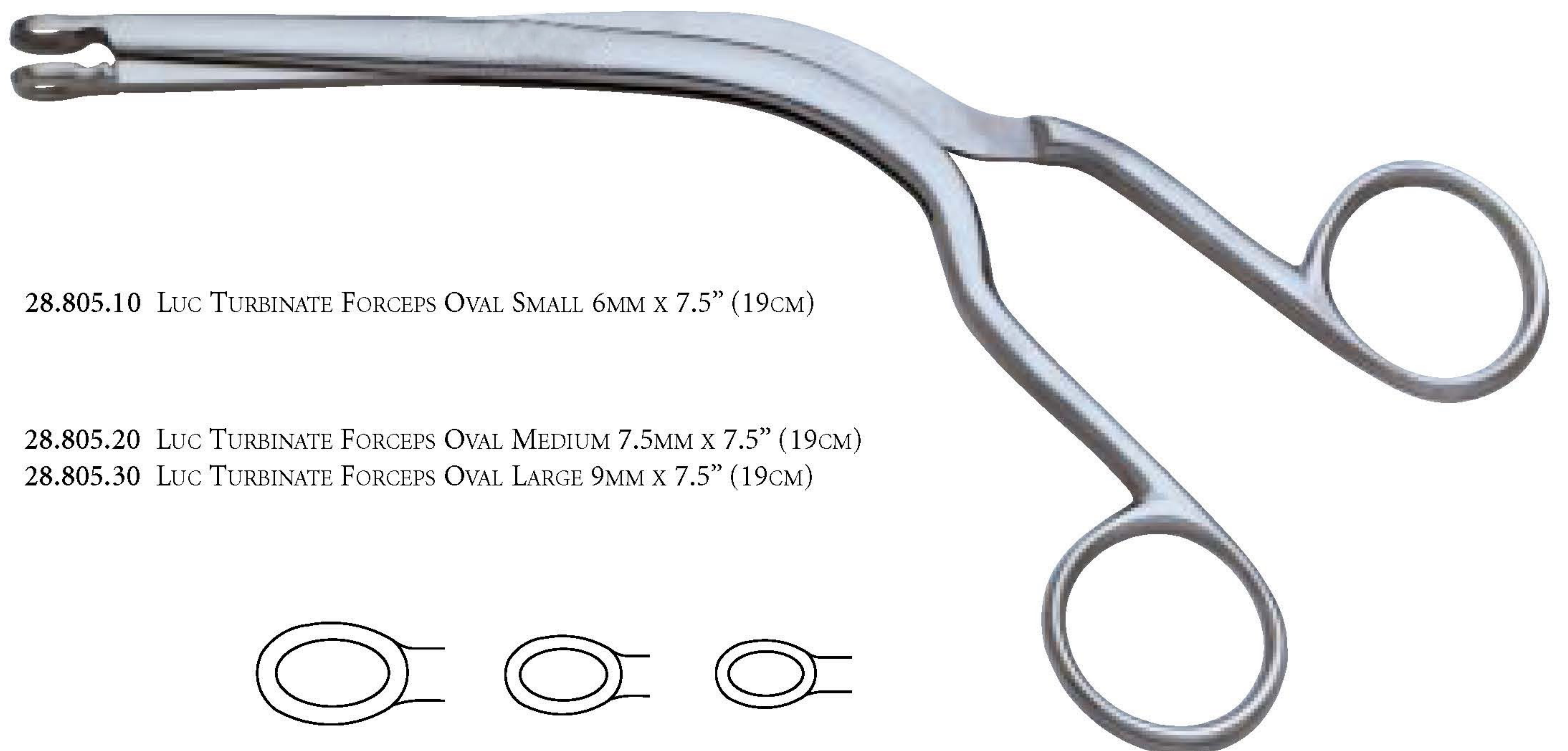

28.805.10 LUC TURBINATE FORCEPS OVAL SMALL 6MM X 7.5" (19CM)

28.805.20 LUC TURBINATE FORCEPS OVAL MEDIUM 7.5MM X 7.5" (19CM)

28.805.30 LUC TURBINATE FORCEPS OVAL LARGE 9MM X 7.5" (19CM)

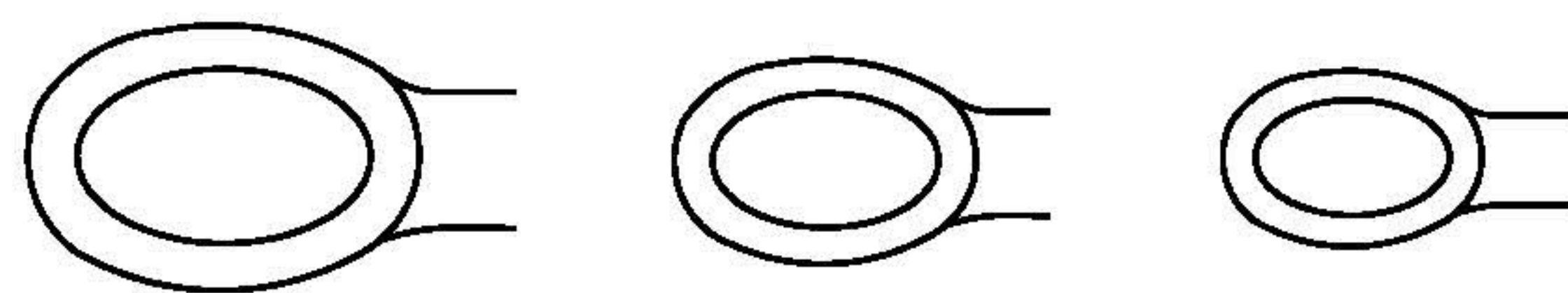

Large

Medium

Small



30.300.10 DAVIS BOYLE MOUTH GAG FRAME CHILD

30.300.30 DAVIS BOYLE MOUTH GAG FRAME ADULT (NOT ILLUSTRATED)



30.345.20 DOUGHTY TONGUE PLATE 2.5" (6.25CM) WITH 2MM SLOT

30.345.30 DOUGHTY TONGUE PLATE 3" (7.5CM) WITH 3MM SLOT

30.345.40 DOUGHTY TONGUE PLATE 3.5" (9CM) WITH 5.7MM SLOT

30.345.50 DOUGHTY TONGUE PLATE 4" (10CM) WITH 7MM SLOT

30.345.60 DOUGHTY TONGUE PLATE 4.5" (11.5CM) WITH 8MM SLOT

WE ALSO SUPPLY SPARE TEETH GUARDS/PROTECTORS FOR MOUTH GAGS, PLEASE CONTACT US FOR DETAILS OR REFER TO OUR PRICE LIST

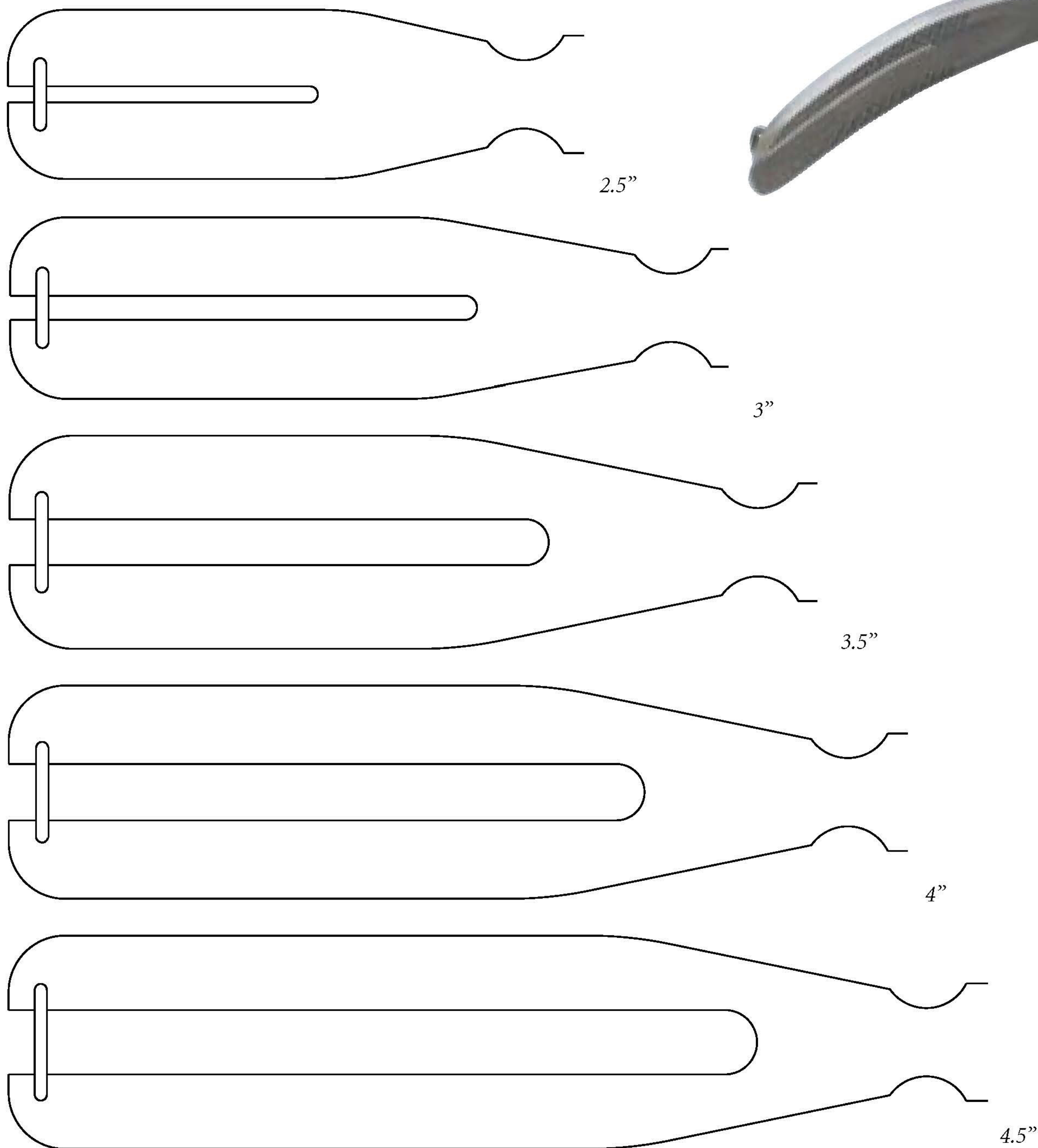

BIPODS AND PLATES

Our Draffin Bipods are made from specially hardened stainless steel to ensure they do not bend or deform whilst in use.



30.430.05 DRAFFIN BIPOD 4 RINGS 15" (38.5CM) PAIR

30.430.10 DRAFFIN BIPOD 4 RINGS 19" (48CM) PAIR (NOT ILLUSTRATED)



The Magauran plates are used with both child (15") and adult (19") bipods.

30.440.10 MAGAURAN PLATE 16" (40.5CM)

TONSIL DISSECTORS AND FORCEPS



30.580.10 MOLLISON TONSIL RETRACTOR/DISSECTOR 8.25" (21CM)



30.680.20 DENIS BROWNE TONSIL HOLDING FORCEPS LARGE 8" (20CM)

ADENOID CURETTES



The Cage on the jaw of the St Clair Thomson Currettes features spikes to securely hold the adenoids whilst the cutting blade slices it. The cage assembly may be disassembled for cleaning and blade sharpening.

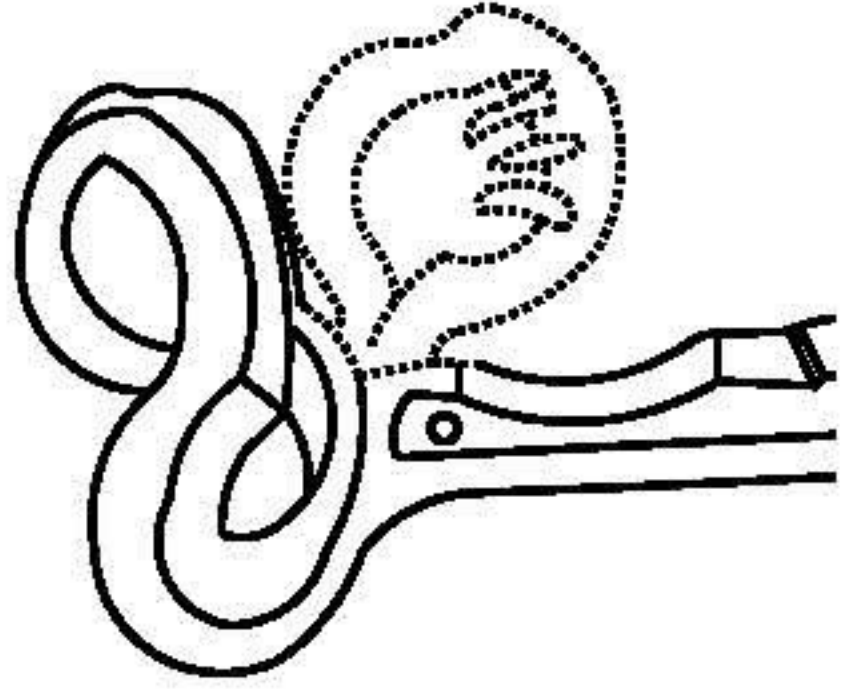

30.960.30 ST. CLAIR THOMSON ADENOID CURETTE 1.5 12MM X 8.5" (21.5CM)

- 30.960.10 ST. CLAIR THOMSON ADENOID CURETTE 0 8.5"(21.5CM) X 8MM
- 30.960.20 ST. CLAIR THOMSON ADENOID CURETTE 1 8.5"(21.5CM) X 10MM
- 30.960.40 ST. CLAIR THOMSON ADENOID CURETTE 2 8.5"(21.5CM) X 14MM
- 30.960.50 ST. CLAIR THOMSON ADENOID CURETTE 3 8.5"(21.5CM) X 16MM
- 30.960.60 ST. CLAIR THOMSON ADENOID CURETTE 4 8.5"(21.5CM) X 18MM

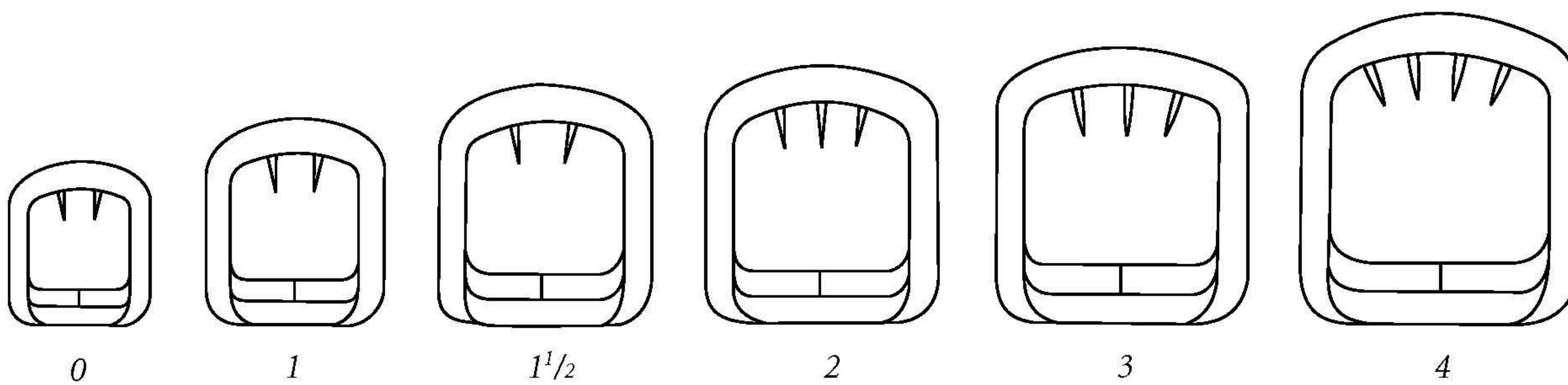

TONSIL SNARE



30.895.10 EVE TONSIL SNARE 11" (28CM)

GOUGES AND MALLETS

The Jenkins gouge is suited for nasal bone fractures and removal of the nasal hump. Other sizes are also available, as are other nasal gouges such as Tilley, Killian and Guy.



40.530.20 JENKIN GOUGE STRAIGHT 6MM X 5.5" (14CM)

40.530.25 JENKIN GOUGE STRAIGHT 8MM X 5.5" (14CM)

This mallet is also commonly referred to as a Toffee Hammer or Mallet. Due to its light weight and small size it is easy to control and is popularly used with chisels, osteotomes and gouges for a variety of minor orthopaedic procedures.



40.798.10 SMALL MALLET STAINLESS STEEL 8.5OZ SMOOTH HEAD

SYRINGES

This syringe is designed to be used with rubber stopped cartridges. The syringe will self aspirate when used with the correct cartridges.

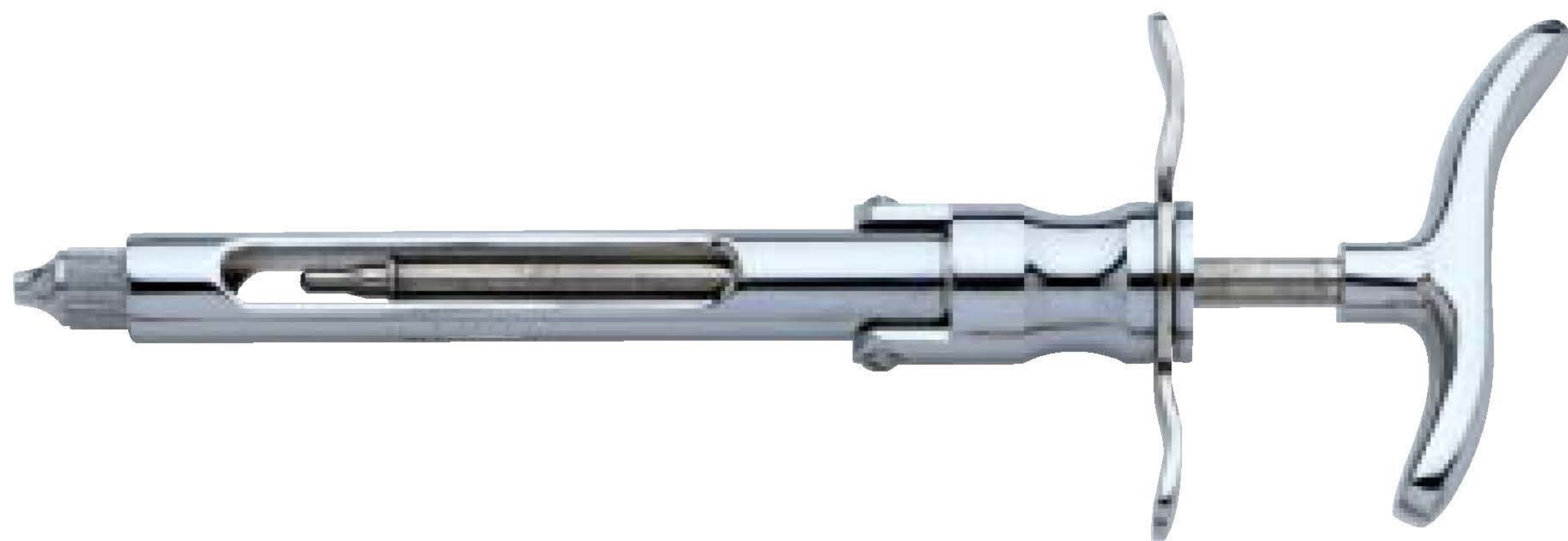

745.550.40 DENTAL CARTRIDGE (A) SYRINGE SELF ASPIRATING 2.2ML

DIATHERMY NEEDLES & CABLES

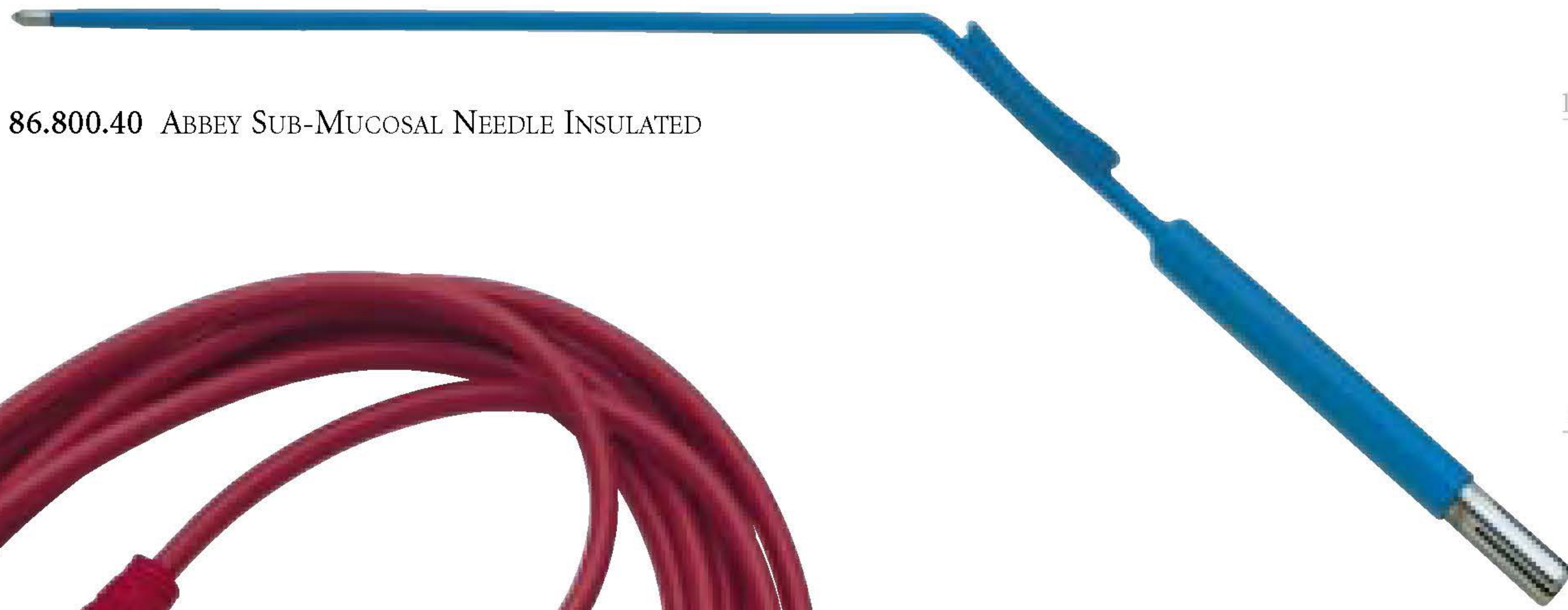

86.800.40 ABBEY SUB-MUCOSAL NEEDLE INSULATED



86.251.20 DIATHERMY CABLE 3 METRES PIN (4MM) END

86.251.40 DIATHERMY CABLE 3 METRES PIN (8MM) END (NOT ILLUSTRATED)

The Abbey Needle has an insulated diathermy coating to allow it to be used for mucosal cauterisation.

Our diathermy cable is designed to be used with diathermy or monopolar forceps and instruments. Available in 2 pin sizes, 4mm or 8mm.

BIPOLAR FORCEPS & CABLES



87.660.20 TIMESCO BIPOLAR FORCEPS STRAIGHT 7" (18CM) BROAD 1.00MM TIP

87.850.20 TIMESCO BIPOLAR CABLE 3 METRES EURO SILICON



A full range of Bipolar Forceps is available in our Bipolar Forceps brochure.

Our Bipolar cable is designed for use with bipolar forceps and instruments. Available with a European fitting (as shown) or a U.S.A. two pin fitting (not shown).

Roras Road, New Adalat Grah
Sialkot-51310 Pakistan

Cell: +92-344-6300124 

Cell: +92-321 6115424

Email: info@mersamedical.com

Email: shahzad@mersamedical.com

Web: www.mersamedical.com



Mersa Medical
I N S T R U M E N T S
Manufacturer & Exporter of Quality Instruments